

H E W L E T T - P A C K A R D

HP CHANNELS

Information For Hewlett-Packard's Value-Added Businesses

June 1987



Introducing the new HP-UX Precision Architecture family

Editor
Tracy Wester

HP Channels is published monthly for Hewlett-Packard's value-added businesses to provide you with information about HP's products and services to help you be more successful.

For further information on any of the products and services discussed in *HP Channels*, please contact your HP sales rep.

See back cover for subscription information.

Note: Not all HP computer products are sold and supported in all countries. Please check with your local HP sales office.

Hewlett-Packard does not warrant the accuracy of the information provided in HP Channels and shall not be liable for any use made of the information contained herein. Information provided in HP Channels is subject to change without notice.

On the cover

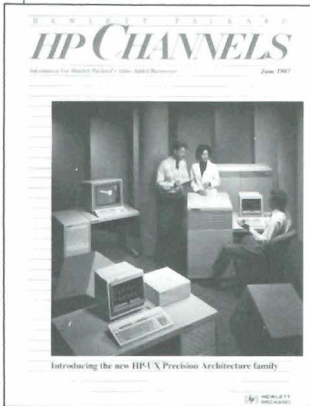

Introducing three new advanced computer systems – ranging from a high-performance superworkstation, to a new top-of-the-line superminicomputer for engineering, manufacturing, and scientific-computing applications. See articles beginning on page 10.

Table of Contents

PARTNERS WITH HP

- 1** Building For The Future: The 1987 Commercial Software Supplier Conference

PRODUCT NEWS

Customer Support

- 2 Training**
HP Offers On-site Service Training
Print Central Customer Training Now Available
HP LaserJet Printer Family Enhanced Service Training
PC/Peripherals Self-paced Mentored Training News

Business Computers

- 3 Precision Architecture**
Introducing the HP 3000 Series 950: New Top-of-the-Line HP 3000
HP 3000 Series 950 Data Communication Capability
- 4 HP 3000**
HP Easytime Release
HP MICRO 3000XE Outperforms MicroVAX II
Print Central Improved With New Direct Mode
Print Central and Resource Sharing Support
HP Lasedet 2000 Printer

Technical Computers

- 7 HP 1000**
HP 1000 A400 Conversion is Easy
HP 1000 E/F-Series to A-Series Upgrades Now Available
HP 1000 Subsystem Software Upgrade Credits Explained
HP Ada/1000 Now Orderable
HP 94250B Forms/1000-II Not Supported on HP 1000 A600

10 HP Precision Architecture¹ HP-UX

HP Precision Architecture Family Expands with Three New Systems
Introducing HP 9000 Model 850S – HP's Fastest HP-UX Precision Architecture System
Introducing the HP 9000 Model 825S Superminicomputer
HP 9000 Model 825SRX Superworkstation Introduced
HP 9000 Model 840S – Double the Terminals. Four Times the Memory
Introducing Networking Products on the HP 9000 Models 825 and 850
New Native Language I/O Products For HP 9000 Series 800
HP 9000 Series 800 Upgrade Program Expanded and Improved
New Peripherals Supported on the HP 9000 Series 800

Correction: Distribution of RMTERM/HP-UX Contributed Library Tape

- 17 HP 9000**
HP Adds New 2D Graphic Subsystem to HP 9000 Model 350
HP 9000 Series 300 HP-UX Release 5.3 And 32-User Product
New Release of HPtoday
Expanded Family of ME Solutions
Announcing HP PCDS Revision 1.1
New HP PCDS System Configurations

Personal Computers

- 21 General**
WordStar/MailMerge to be Obsoleted
- 21 Desktop**
HP Vectra 3000 PC: Even Better with New HP Production Planning/PC
Announcing New HP AdvanceLink for HP Vectra PC
HP Vectra PC: Most Frequently Asked Questions
Business Management Portfolio Now Packaged with Gallery Collection
European Symbols Now Available for Graphics Gallery
SRM I/F Card for HP Vectra PC
AdvanceWrite/PageMaker: The Perfect DTP Solution
Localized HP Vectra PC OS Price Increase – Correction

Peripherals

- 26 Mass Storage**
HP 9133/34H Obsolescence Reminder
HP 35401A: Cost Justification
New Autoloading, 5/8-inch Tape Drives: High Performance and Compact Design

27 Networks

HP StarLAN Now Shipping
HP OfficeShare Networking Family For PCs

28 Printers

HP LaserJet Series II and LaserJet 2000 Printers Supported on HP 3000 Systems
Benefits of 13.3 cpi Option on HP 256XB Printers
Increase Throughput on HP 2567B

Supplies

30 Supplies

Fill Supply Needs Quickly with the HP Computer Users Catalog
Prices Reduced for HP Flexible Discs
HP-IL Video Interface Discontinued
HP DIRECT Order Phone Numbers

CROSS-LICENSING CLASSIFIEDS

- 32** Software Packages Available and Wanted

HP Computer Museum
www.hpmuseum.net

For research and education purposes only.

Building For The Future: The 1987 Commercial Software Supplier Conference

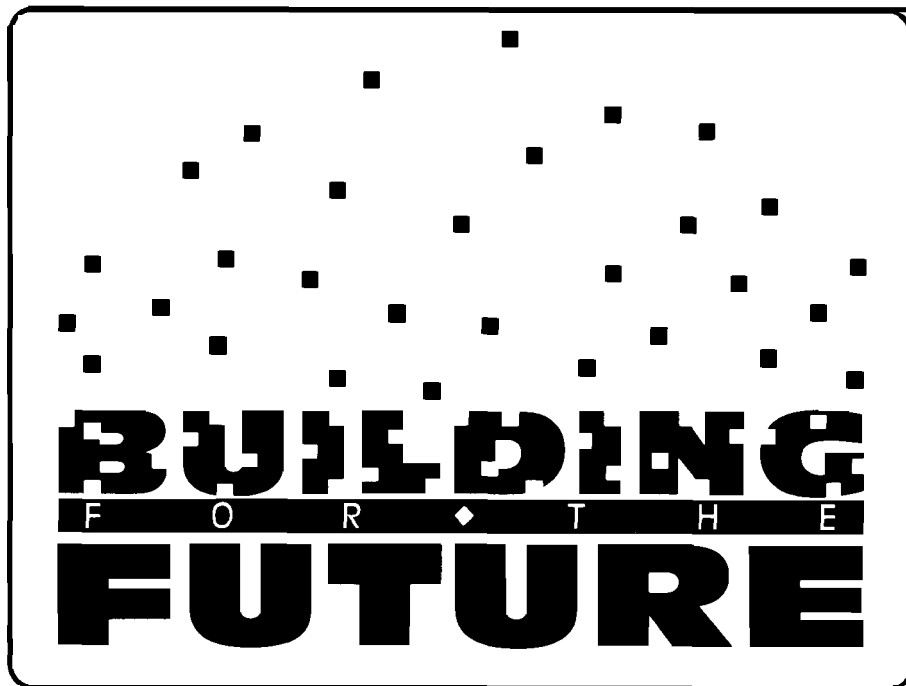

More than 350 enthusiastic people attended "Building For The Future," the 1987 Commercial Software Supplier Conference held at the Santa Clara, California, Marriott Hotel on April 5-7.

The attendees enjoyed a wine-tasting on Sunday evening, April 5. The next morning John Young began the conference by speaking about the state of the U.S. industrial competitiveness and recommendations from President Reagan's Commission on Industrial Competitiveness. John was chairman of that commission in 1983 and until the commission completed its work in 1984.

Next, Dick Alberding, executive vice president of Marketing and International, spoke about the changes that occurred within HP during the past two years and the heightened role of value-added businesses. Chuck House, director of Corporate Engineering, spoke

about RISC technology as a basis for new products from now until the late 1990s as well as the acceptance of new technology into commercial products such as the commercialization of automobiles during the turn of the last century.

Toby Hecht, president of Hecht and Associates, described the new global changes taking place in the marketplace and what sales people must do to remain competitive and profitable. Doug Spreng, general manager of HP's Commercial Systems Business Unit, presented the commercial systems strategy, including information on products released during the last year.

Monday evening was capped by the Product Fair and California Cuisine Theme Dinner. The Product Fair featured the HP MICRO 3000, the HP

3000 Series 930, new peripherals, personal computer products and applications, and the new HP LaserJet 2000 printer.

The California Cuisine Theme Dinner featured food from several regions of California. A 20-foot-long replica of the Golden Gate Bridge commemorated the 50th Anniversary of the Golden Gate Bridge in San Francisco. A Conestoga covered wagon represented the Old West, a boardwalk represented the beaches of California, and a Spanish mission represented the Spanish heritage of California. The food selection included oyster shooters, tortellini, miniature egg rolls, barbecued baby-back pork ribs, and quesadillas with verde sauce.

Tuesday morning opened with workshops, followed by Chuck Jepson, director of HP Office Systems Business Unit. Chuck spoke about the opportunities in this growing marketplace and how software suppliers can take advantage of these opportunities.

Following Chuck was the HP Management Forum. This roundtable consisted of Ralph Godfrey, U.S. commercial sales manager; Bill Murphy, marketing manager of Business Systems Sector; and Sharon Jacobs, marketing manager of Computer Systems. The roundtable addressed issues raised by HP 3000 software suppliers concerning our strategies, products, and program.

The general sessions were wrapped up by Bill Murphy who reviewed the people and programs in place to make our software suppliers successful. On Tuesday afternoon, software suppliers attended the vertical marketing workshops which were the last sessions of a very successful conference.



Customer Support

Training

HP OFFERS ON-SITE SERVICE TRAINING

Hewlett-Packard Customer Service Training offers a worldwide, on-site training program for computer and instrument users who desire self support.

The on-site training program provides users with the same training that HP's own customer engineers receive, but with the flexibility of time and location. This program is especially advantageous to users with a large installed product base, or someone involved in security-sensitive projects in remote areas.

On-site service courses – standard or specially developed – are available for a wide variety of computer and peripheral products. The program also includes a select group of HP instruments.

With 25 years of customer training experience and backed by HP's technical support organization, Customer Service Training is committed to providing self-support users with training of the highest quality. For more information, please contact Kathy Martin or Wei Huang at 415-691-5300/15905 or 800-523-0696 (in the U.S.) or 800-882-9595 (in California).

Training

PRINT CENTRAL CUSTOMER TRAINING NOW AVAILABLE

Customer training for Print Central is now available. Print Central Modular Training (PCMT) contains four modules geared toward the office products coordinator and covers the design, planning, and implementation of Print Central. The training also has one module that teaches end users how to use the product on a day-to-day basis.

A unique feature of this training's design is that it can be given as either a self-paced or stand-up course. In the self-paced format, students are allowed to proceed at their own speed and take only the modules that apply to their specific job requirements. If taught as a stand-up class, students can benefit from interacting with an instructor and fellow learners.

One copy of PCMT is provided to the user with each Print Central documentation set. Additional copies may be ordered through Direct Marketing Division (DMK), PIN 36890-90044.

Training

HP LASERJET PRINTER FAMILY ENHANCED SERVICE TRAINING

Hewlett-Packard Customer Service Training is offering HP LaserJet printer family service training in 1987.

Course 50042A was developed to train service personnel to diagnose, troubleshoot, and maintain the HP 2686A/D (HP LaserJet, Plus, 500) and the 33440A (Series II) printers in an office environment. It is a five-day class which expands on the service technology available through the regular SMT

(Self-paced Mentored Training – Course 05092A, Option 0231024).

Participants will learn to service the HP LaserJet printers from the perspective that it is an integral part of an office PC network. Hardware service knowledge is reinforced with selected PC-HP LaserJet printer configuration methods. The class is structured as 40 percent lecture and 60 percent lab, to ensure ample hands-on experience.

The schedule for Course 50042A through 1987 is listed below.

At Customer Service Training, Mountain View, California

June 15-19

August 3-7

September 21-25

December 7-11

At Rockville Training Center, Rockville, Maryland

June 15-19

August 10-14

September 14-18

November 16-20

For pricing information, please contact Customer Service Training in Mountain View: 415-691-5300, or 800-523-0696 (in the U.S.), or 800-882-9595 (in California).

Training

PC/PERIPHERALS SELF-PACED MENTORED TRAINING NEWS

HP's Customer Service Training (CST) is offering the following self-paced mentored training courses to users who want to maintain their HP personal computers and/or associated peripherals.

Course Number 05092A

Option	Description	Length (days)
001	HP Portable computer (110)	2
002	HP 150 personal computer	3
003	HP 150 I personal computer	3
004	HP 150 emulator	1
005	HP-85A/B personal computer	2
006	HP-86A/B personal computer	2
007	HP 9121S/D disc drives	1
008	HP 9122 disc drive	1
009	HP 9133134 disc drive	1
010	HP 9114A disc drive	1
011	HP ThinkJet printer (2225A)	1
012	HP 82905A printer	1
013	HP 7470A plotter	1
015	HP 7475A plotter	1
016	HP 9872A plotter	1
017	HP 262X terminals	1
018	HP 264X terminals	3
019	Etherlink/150	1
020	HP Vectra PC (72425A)	3
021	HP 150 II personal computer	3
022	HP Integral PC (9807A)	4
023	HP LaserJet printer (2686A/D)	4
024	HP LaserJet Series II printer (33440A)	3

The courses are being held at the training centers listed below.

- CST Headquarters, 100 Mayfield Avenue, Mountain View, California
 - June 8-12
 - August 10-14
 - September 28-October 2

Rockville Training Center, 2096 Gaither, Rockville, Maryland

- June 22-26

For additional information or course registration, please contact Customer Service Training at 415-691-5300, or 800-523-0696 (in the U.S.), or 800-882-9595 (in California).

Business Computers

Precision Architecture

INTRODUCING THE HP 3000 SERIES 950: NEW TOP-OF-THE-LINE HP 3000

The product you have been waiting for is here: the HP 3000 Series 950. By combining HP Precision Architecture with HP's proprietary NMOS III VLSI technology, the HP 3000 Series 950 offers users an excellent solution to their high-end commercial data processing needs. For installed base accounts, the HP 3000 Series 950 is ideally suited as a performance upgrade for an HP 3000 Series 70. For new accounts, the HP 3000 Series 950 will open up doors to large data processing environments.

Powerful new processor, technology leadership

The HP 3000 Series 950 is the second HP 3000 system to be implemented using HP Precision Architecture. As a member of the HP 3000 family, the Series 950 is compatible with existing HP 3000 systems. Like the HP 3000 Series 930, it offers 48-bit addressing, more than the 32-bit address space offered by other 32-bit computers today. This means that the HP 3000 Series 950 address space is 65,536 times larger than a typical competitive system. To the users, this means that they will not have to worry about address space limitations for the next couple decades.

At 7 MIPS, the HP 3000 Series 950 is the most powerful HP 3000 introduced to date. By using HP's NMOS III VLSI technology, the entire HP 3000 Series 950 CPU was put on a single chip containing 144,000 transistors. Furthermore, the entire processor, including a 128-Kbyte cache, 4-Kbyte Translation Lookaside Buffer and Floating Point Coprocessor, is on a single printed circuit board.

Because it has so few components, the HP 3000 Series 950 has a small footprint compared with other machines

in its class. Fewer parts also means higher reliability, low cooling requirements, and low electrical power needs. This translates into lower cost of ownership for the user.

The HP 3000 Series 950 uses a three-level I/O hierarchy incorporating a System Memory Bus that is 64-bits wide and operates at 100 Mbytes per second. This advanced bus structure provides users with a very high I/O bandwidth.

The HP 3000 Series 950 comes standard with 32 Mbytes of main memory, but will support up to 128 Mbytes of memory to accommodate the very large memory requirements of future applications. At first release, the HP 3000 Series 950 supports the same I/O and peripheral configuration maximums as the HP 3000 Series 930. In the future, disc drive support will be increased. Increasing the number of workstations supported will be investigated.

The aggressively priced HP 3000 Series 950 preconfigured system includes the SPU, 32 Mbyte main memory, MPE XL operating system, System Dictionary/XL, and network and relational database management systems. The HP 3000 Series 950 delivers on the promise of industry-leading price/performance. And since it's on the June 1 HP Price List, users can order an HP 3000 Series 950 today. Furthermore, the HP 3000 Series 950 is on schedule for shipment by the end of this year.

HP 3000 Series 930: new product structure

As of June 1, the HP 3000 Series 930 is being repriced in response to

new product and pricing announcements by our major competitors. In addition, the standard memory on the HP 3000 Series 930 has been increased from 16 to 32 Mbytes. This was made possible by the new 1 Mbit RAM technology. Also, maximum memory support on the HP 3000 Series 930 has been increased from 24 to 96 Mbytes.

The HP 3000 Series 950: a winning combination of advanced technology, high performance, and aggressive pricing.

Precision Architecture

HP 3000

SERIES 950 DATA

COMMUNICATION

CAPABILITY

Effective on the June 1 HP Price List, options will be added to the LAN3000/XL local-area-network link and the NS3000/XL network services to provide networking capability for the HP 3000 Series 950 computer system. Addition of these options permits the HP 3000 Series 950 to be added to an IEEE 802.3 local area network for communication with other MPE/XL and MPE/V (HP MICRO 3000, MICRO 3000XE, and HP 3000 Series 37, 39, 4X, 5X, 6X, and 70) systems on the same LAN.

The products affected by these additional options are NS3000/XL (HP36920 AIR) and LAN3000/XL (36921A).

Product No.	Description
<i>HP 3000 Network Service Product</i>	
36920	HP Network Services for MPEIXL-based systems
Opt. 440	For HP 3000 Series 950
<i>HP 3000 Network Link Product</i>	
36921A	LAN3000/XL Link for MPEIXL-based systems
Opt. 400	For HP 3000 Series 950

HP 3000

HP EASYTIME RELEASE

Not available in Europe

HP Easytime, the new software program that allows novice users to run MPE without a sophisticated knowledge of the operating system commands, has been released on UB-Delta-3. Now HP MICRO 3000 users can take advantage of the convenience of HP Easytime.

For all users who have ordered an HP MICRO 3000, HP is making special accommodations so that there is *no need to upgrade* to UB-Delta-3. For orders received by HP's Software Distribution Center (SDC) before May 14, a special HP Easytime tape has been created that will be sent out with special installation instructions that are tailored for the novice end user.

Orders received by SDC after May 14 will get HP Easytime through the standard subsystem process. This is true regardless of whether the HP MICRO 3000 orders were for UB-Delta-1, 2, or 3. The HP Application Engineer needs to phone in the order to SDC, which will include Easytime on the subsystem tape. (The HP Application Engineers were notified that they needed to change their process).

HP Easytime, like disc caching, is considered user installable. If users

have questions with the procedure, they should follow their normal support procedures (contact your sales rep or local HP Response Center).

HP 3000

HP MICRO 3000XE

OUTPERFORMS

MICROVAX II

Have you ever wondered how the 32-bit, 0.9 MIPS 'Supermicro' MicroVAX II performs in a commercial transaction processing environment? Not nearly as well as the HP MICRO 3000XE, according to a benchmark recently completed at the Business Systems Capacity Planning Center. In fact, in what we feel to be the most critical measure of system performance – peak transaction throughput or 'work' – the HP MICRO 3000XE with 6 Mbytes processed 28 percent more transactions per hour than a 17-Mbyte MicroVAX II. Absolute response time data showed even more than the 28 percent advantage.

What does this extra performance mean to users? They can simply get more work done, faster. They can add more applications without having to upgrade. And since the HP MICRO 3000XE will support more memory than this benchmark could utilize, they could see even more performance out of this cost-effective, office-compatible system. All of this performance at a lower price than the similarly configured MicroVAX II.

With all of the recent DEC-hype, you may still be a little skeptical. This benchmark – the first of its kind – was engineered with total objectivity in mind. The development process will be summarized here. For more information about these benchmark configurations, contact your HP sales rep.

Hardware selection

The hardware was purchased directly through the value-added business that supplied the application software. This equipment is typical of what might be bid in competitive situations with these processing requirements. Configurations for both the HP MICRO 3000XE and MicroVAX II are presented. As you see, they are similarly configured (except for memory).

Hardware	HP (max)	DEC (max)
SPU type	HP MICRO 3000XE	MicroVAX II - BA 123
Main memory	6 Mbytes (8 Mbytes)	17 Mbytes (17 Mbytes)
RS-232 ports	16 (56)	16 (41)
Tape drive	¼-inch cartridge	½-inch cartridge
Disc drive	One HP 7957A total 211 Mbytes One HP 7958A	Three RD53 total 213 Mbytes
Disc controllers	One each mechanism	One RQDX3
Operating system	MPE UB-Delta-1	MicroVMS 4.4

Software

The application software selection was critical to ensuring a totally fair and realistic benchmark. This particular package was chosen because it is an interactive transaction processing application with a reasonable installed base. It has been optimized for each host system yet retains the same functionality in order to be comparable. Specifically, it is a transaction processing application for manufacturing functions making extensive use of database access.

Expertise

To ensure that the application and machine were running in top form, two different non-HP consultants were utilized. The specialist from the VAB application tuned the customizable parameters within the manufacturing software for top performance. In addition, the database 'loading' and script

development was done under their scrutiny to verify that this was totally representative of how manufacturers interact with the application.

A VAX performance specialist was retained to tune the system parameters for top performance. In fact, as each workload was changed, the MicroVAX II was retuned for exactly that system load. This was probably more than most users would do, but there was no expense spared to make sure that this was the top performance that we could obtain from this application on this system.

The same was done on the HP 3000 side. It is interesting to note that MPE's best performance was obtained when run exactly as it was delivered. Since the machine and operating system has been optimized for transaction processing, there was little need to deviate from the factory settings. The MicroVAX II required changes for optimization for this benchmark.

Results

The HP MICRO 3000XE shows higher transaction throughput than the MicroVAX II under similar workloads

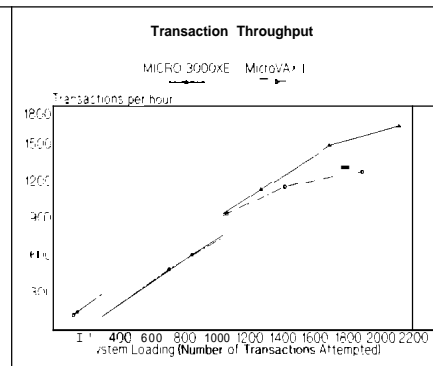

It takes all of the MicroVAX II's 32-bits, 0.9 MIPS, and 17 Mbytes of memory just to equal the throughput of the 6-Mbyte uncached HP MICRO 3000XE. Turn on the disc caching subsystem (included in system price) and the HP MICRO 3000XE can do 28 percent more work. The response time

graph is shown below. The MICRO 3000XE performs better in this category as well.

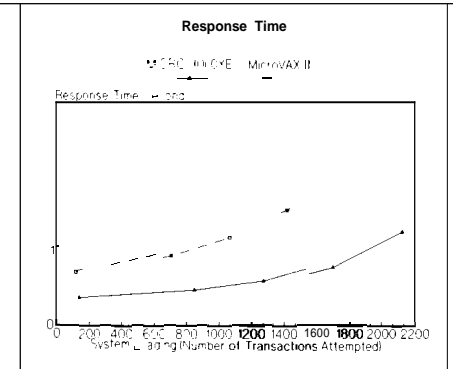

The HP MICRO 3000XE gives you all of this additional performance, but at what price? Our MicroVAX II, one of their standard system building blocks, had a 12 percent higher U.S. list price than our HP MICRO 3000XE. By including hardware and software support, the three-year cost of ownership shows an even greater difference.

In short, using what we consider to be a fair and representative benchmark as a guide, the HP MICRO 3000XE does more work, with less response time degradation, for less money than the benchmarked MicroVAX II. We think that the MICRO 3000XE is simply more system for the money.

HP 3000

PRINT CENTRAL **IMPROVED WITH NEW** **DIRECT MODE**

Print Central offers up to 50 percent faster document throughput, graphics, and improved ease of use with its new Direct Mode. These enhancements are available with the current version of Print Central which began user shipments in March 1987, with UB-Delta-2. Print Central is a low-cost, entry-level,

connections. Resource Sharing allows users to leverage their peripheral investments and optimize the management and control of PC resources.

Both shared printing solutions allow users to access the full capabilities of the HP LaserJet 2000 printer in a shared environment. This includes access to full-page 300 x 300 dpi graphics with products such as Drawing Gallery. Other capabilities that complement Print Central and Resource Sharing are listed below:

Feature	Description	Benefit
Advance paper handling capabilities	Dual 250-sheet input bins and a 1,500-sheet output bin are standard. An optional 2,000-sheet input bin is available.	Reduced printer attending need
Duplex option available	Allows printing on both sides of a sheet of paper.	Reduced paper costs
Fast document throughput	Capable of up to 20 pages per minute.	Users spend less time waiting for printed output.
Low printing cost	\$.01/page printing cost.	Reduced operating costs
More fonts available	34 resident fonts are standard. Up to three HP LaserJet printer font cartridges can be inserted. HP LaserJet printer software are also supported	Provides broad selection of fonts that can be easily accessed by the user.
High duty cycle	Maximum monthly usage rating is 70,000 sheets.	Reduces ongoing maintenance requirements.

The HP LaserJet 2000 printer provides full-featured, high-quality, laser printing capabilities for office users. Together with Print Central or Resource Sharing, the HP LaserJet 2000 printer gives users a high-performance, heavy-duty, shared-printing solution for their office environment.

The HP LaserJet 2000 printer should be configured as an HP LaserJet printer when using it with Print Central or

Resource Sharing. It can be used in either the Processed or Direct Mode. Support of the HP LaserJet 2000 printer does not require a software update.

The HP LaserJet 2000 printer (2684A) was added to the HP Price List on March 2, 1987. Print Central (32593A) and Resource Sharing (32597A) are currently available products.

Also in this issue

<i>Print Central Customer Training Now Available</i>	2
<i>New Release of HPtoday</i>	18
<i>HP Vectra 3000 PC: Even Better With New HP Production Planning PC</i>	21
<i>HP Vectra 3000 PC: Most Frequently Asked Questions</i>	22
<i>HP LaserJet Series II and LaserJet 2000 Printers Supported on HP 3000 Computers</i>	28

Technical Computers

HP 1000

HP 1000 A400 CONVERSION IS EASY

If you are an OEM for the HP 1000 A-Series family of computers or have an application running on the HP 1000 A-Series, it is very easy to move your system to the HP 1000 A400. You may decide to do this in order to offer a lower-performance alternative to the HP 1000 A900 or to offer a lower-cost alternative to the HP 1000 A600. Since the introduction of the HP 1000 A400 in November 1986, a number of OEMs and software suppliers have had the opportunity to test the HP 1000 A400 for use in their systems. The response has been fantastic.

For example, when one OEM installed the HP 1000 A400 and booted their system as if it were an HP 1000 A600, it worked on the first try. They were ecstatic. C&L systems had a similar experience as they recently reported in *Design and Manufacturing* magazine. They did note, however, that the HP 1000 A400 board would not power up in the discontinued Model 6 chassis and that they needed to use "D" MUX drivers as HP had recommended. After running many benchmarks, they concluded that "The A400 is an average of about 11 percent faster under load than the A600 . . . based on typical real-time application use." They were also impressed with the nine-year estimated mean-time-between-failure rate for the HP 1000 A400.

If you currently have a system running on the HP 1000 A900, converting to the HP 1000 A400 would be a terrific way to offer a lower-cost, lower-performance alternative to your customers. If you currently have a system running on the HP 1000 A600, the HP 1000 A400 may help you to be even

more competitive in your marketplace or possibly to increase your profit margins. In addition, using the HP 1000 A400 may be a way to solve new application needs. For additional information, call your local HP sales rep.

HP 1000

HP 1000 E/F-SERIES TO A-SERIES UPGRADES NOW AVAILABLE

If you are an OEM with HP 1000 E- or F-Series customers, you could earn incremental money by participating in our HP 1000 Upgrade Program. If you are supporting both HP 1000 EIF-Series customers and A-Series customers, you could also realize the benefits of decreased support overhead by encouraging your customers to upgrade to the HP 1000 A-Series. By upgrading their systems, your customers would in turn benefit from lower costs of ownership and increased system performance. Here is a summary (U.S. list prices) of the upgrade program covering migration from HP 1000 E/F-Series to A4001 A900 that went on the HP Price List on April 1, 1987.

HP 1000 E/F-Series to A900

- Receive \$2,000 return credit towards any E- or F-Series computer when you order Option 010 for the following HP 1000 A900 models: 2199C, 2199D, 2139A, 2439A, 2839A.

- Receive return credits for selected HP 1000 A900 memory and I/O products. (See product list and prices at the end of this article).

Receive 100 percent upgrade credit towards software subsystems that are common between the HP 1000 E/F-Series and the A900. The incremental price difference between E/F-Series (700-level products) and the A900 (900-level products) is paid for by ordering Option 897. (See the accompanying article for a more detailed explanation of subsystem software upgrades).

HP 1000 E/F-Series to A400

Receive \$200 return credit for any HP 1000 E- or F-Series computers when you order Option 010 for the following A400 models: 2424A, 2434A, 2484A.

Receive return credits for selected HP 1000 A400 memory and I/O products. (See list and prices at end of article).

Receive no-cost use of software subsystems that are common between the HP 1000 E/F-Series and the A400. If a user previously purchased subsystem software for use on their HP 1000 E- or F-Series, they have the right to use this software on their new HP 1000 A400 without additional cost. They don't even need to order it; they just move it from the HP 1000 E- or F-Series when they move their application and reload it on their new HP 1000 A400. (Again, see the accompanying article for details on subsystem software upgrades).

For further information about these and other upgrade programs available for HP 1000 computers, please contact your local HP sales rep.

I/O and memory credits

Product No.	Description	Credit*
<i>Memory</i>		
12746HN	64 Kbytes	\$100
12747HN	128 Kbytes	250
12699HN	256 Kbytes	350
12749HN	512 Kbytes	750
12779HN	256 Kbytes Check bit	100
12780HN	512 Kbytes Check bit	250
12666HN	1.0 Mbyte Check bit	400
<i>I/O</i>		
12792AN	8-channel MUX	300
12792BN	8-channel MUX	300
12821AN	HP-IB	75
12966AN	BACI	100
13175BN	MAC I/O	75

* U.S. list price, contact your sales rep for the credit prices in your country.

HP 1000

HP 1000 SUBSYSTEM SOFTWARE UPGRADE CREDITS EXPLAINED

100 Percent Software Upgrade Credit applies to subsystem software that is common between the RTE-6/VM environment and the RTE-A environment. There are two types of common software: compatible common and incompatible common.

Compatible common software products are listed below. If you are upgrading from an HP 1000 E- or F-Series to an HP 1000 A900, order the product with Option 897. Users upgrading from an HP 1000 EIF-Series to an A400, do not need to order these products. Since they originally purchased their subsystem software at a higher lever than the HP 1000 A400, they are allowed to port from their old system to their new system at no charge.

Product No.	Description	HP 1000	
		For A900	For A400
92836A/R	FORTRAN 77	Order Opt 897	N/C
92833A/R	Pascal	Order Opt 897	N/C
92857A/R	BASIC	Order Opt 897	N/C
92860A/R	DEBUG	Order Opt 897	N/C
92069A/R	IMAGE I	Order Opt 897	N/C
92081A/R	IMAGE II	Order Opt 897	N/C
92861A/R	DGL	Order Opt 897	N/C
92862A/R	AGP	Order Opt 897	N/C
91750A/R	US	Order Opt 897	N/C
91781A/R	RJE	Order Opt 897	N/C
91782A/A	MRJE	Order Opt 897	N/C

Incompatible common software are those products that have the same function in each operating system environment, such as FORMS and QDM, but have different product numbers. Users with these subsystems can make special arrangements to receive appropriate credits, licenses, manuals, and software on an exception basis.

Contact your local HP sales rep for information or assistance regarding this or any other upgrade program for HP 1000 computers.

HP 1000

HP Ada/1000 Now ORDERABLE

HP is pleased to announce that the HP Ada/1000 compiler for the HP 1000 A-Series will be orderable on the June 1 HP Price List. We are making this compiler orderable prior to its release to manufacturing in anticipation of the long-selling cycles to government agencies and OEMs. We expect the validated HP Ada/1000 compiler to start shipping in September of 1987.

We believe that the HP Ada/1000 compiler will be key to both preserving and also expanding our business with the U.S. Government and with other vendors of computer systems to foreign military agencies (NATO. etc).

Increasingly, government agencies and OEMs are required to write their applications in Ada. This is expected to reduce training and software costs to the government. Ada offers a standard development environment and Ada source code is highly portable even across different operating systems.

The following HP Add1000 products are now orderable.

Product No.	Description
92125A	HP Add1000 license
Opt. 400	For HP 1000 A400 CPUs
Opt. 600	For HP 1000 A600 CPUs
Opt. 700	For HP 1000 A700 CPUs
Opt. 890	For HP 1000 A900 CPUs
92125R	Right-To-Copy HP Add1000
Opt. 400	For HP 1000 A400 CPUs
Opt. 600	For HP 1000 A600 CPUs
Opt. 700	For HP 1000 A700 CPUs
Opt. 890	For HP 1000 A900 CPUs

Ada is available on Linus Cartridge Tape (Opt. 022) and on 1600 bpi mag tape (Opt. 051) media.

HP Ada/1000 is source-code compatible with HP Add9000 which runs on the HP 9000 Series 300. This makes source-code migration to and from the two families much easier. For more technical information on HP Ada/1000, order the datasheet, PIN 5954-8565.

HP Add1000 is one of the best real-time Ada compilers/processors on the market. Ada is a key requirement for embedded systems, and mission-critical systems where real time is crucial. Preliminary benchmarks indicate that the performance of the code generated with

the HP Ada/1000 compiler is very comparable to FORTRAN 77. HP has now complemented its excellent HP Ada/9000 workstation offering for the HP 9000 Series 300 with HP Ada/1000, which is peaked for real time.

HP 1000

HP 94250B FORMS/1000-II NOT SUPPORTED ON HP 1000 A600

The latest HP 1000 Ordering Guide (PIN 5954-8564) mistakenly indicates on pages 42 and 43 that 94250B Option 600 is usable on both the HP 1000 A600+ and A600 computers. That is *not* correct. To help avoid misunderstandings on this point, please cross out /A600 in the line that reads "Use in A600+/A600 computer" for the 94250B, 94250R, and 94250E on your reference copy of the ordering guide on page 42 at lowest right and at top of page 43. The next revision of the ordering guide will expressly exclude use in A600 computers.

HP Precision Architecture/HP-UX

HP PRECISION ARCHITECTURE FAMILY EXPANDS WITH THREE NEW SYSTEMS

HP introduces three new advanced computer systems – ranging from a high-performance superworkstation, to a new top-of-the-line superminicomputer for engineering, manufacturing, and scientific-computing applications. The new HP 9000 Model 825SRX, Model 825S, and Model 850S complement and extend HP's existing line of HP 9000 systems.

By offering superior price/performance, excellent networking, broad compatibility, and low cost of ownership, HP challenges the competition in the fast-growing manufacturing, engineering, and scientific computing markets.

The HP 9000 Series 800 line now includes:

- The top-of-the-line HP 9000 Model 850S superminicomputer designed for applications requiring very high speed and performance, large memory expandability, and wide I/O bandwidth. It supports 50-plus users, with a maximum of 90 terminal and other serial-device connections.
- The HP 9000 Model 840S computer provides midrange performance for scientific, engineering, and manufacturing applications, and software-development tasks. It supports 16 to 50 active users, with a maximum of 128 terminal connections.

The HP 9000 Model 825S computer bridges the gap between workstations and larger systems. As the entry-level system in the HP Precision Architecture family of multiuser systems, it serves 2 to 24 active users, and supports a maximum of 64 terminal connections.

- The HP 9000 Model 825SRX superworkstation is believed to deliver more performance than any other workstation

available today. Its computational performance (80-nanosecond instruction cycle time, virtual-memory address space of 281,000 GBytes and high-speed, bit-mapped graphics) places the HP superworkstation at the top of this new class of products.

Let's take a look at an overall comparison of each of the new products:

	HP 9000 Series 800 family specifications		
	Model 825S	Model 840S	Model 850S
Relative Performance	7	1	1.6
Memory (std/max)	8/56 Mbytes	8/96 Mbytes	16/128 Mbytes
I/O Slots (std/max)	7/12	12/26	18
HP-UX license	16	16	32

The real benefit of our new architecture is the fact that in only 12 months, we've expanded from one computer to a full family of systems that offer superior performance at a much lower price. In addition to providing superior price/performance, one of our strongest competitive advantages is HP's adherence to industry standards. Because all HP 9000 computers use the HP-UX operating system, users benefit from a high degree of compatibility across the entire line, as well as compatibility with programs and applications that are developed under UNIX® operating systems on other vendors' computers.

HP Precision Architecture/HP-UX

INTRODUCING HP 9000 MODEL 850S – HP'S FASTEST HP-UX PRECISION ARCHITECTURE SYSTEM

HP proudly introduces the most powerful HP-UX system offered in the company's 21-year history in the computer business. Broadening the HP 9000 Series 800 family of superminicomputers, the Model 850S provides higher performance and a growth path for the user whose computing needs extend beyond the HP 9000 Model 840S.

Price/performance leadership

The common foundation of the HP 9000 Model 850S and the other Series 800 members demonstrates the scalability and ability of HP's Precision Architecture to provide lasting value for our users. By utilizing HP's proprietary NMOS-III VLSI circuit technology, the HP 9000 Model 850S stands as the price/performance leader in its class. The U.S. list price of the HP 9000 Model 850S is about half the price of DEC's equivalent performing machines, the VAX 8550 and 8650 computers. With estimated relative throughput of 7.2 (to the HP 9000 Model 840S at 4.5), the HP 9000 Model 850S outperforms other superminis in its price class. The HP 9000 Model 850S offers up to 60 percent better CPU performance and greater expandability than the HP 9000 Model 840S while maintaining the same price/performance

edge over its competitors (see table below for comparisons).

HP 9000 Model 850S versus competition				
	HP 9000 Model 850S	DEC VAX 8550	DEC MV15000/20	IBM 4381/13
<i>Performance</i>				
MIPS	7.2	6.9	6.4	6.8
Kflops*	715	1100	N/A	1600
<i>Base Price (\$K) (U.S. list)</i>				
	200	419	226	440
<i>Price/Performance</i>				
\$K/MIP	28	61	35	65
\$/Kflop	280	381	-	275

*Based on the double precision Linpack benchmark

Ideal for multiuser applications

Similar to the other members of the HP 9000 Series 800 family, the Model 850S is targeted to those customers interested in a general-purpose, high-performance, UNIX® operating system-based system. The HP 9000 Model 850S has the power to serve a department of scientific or engineering users performing computation-intensive tasks. In communications, the high data throughput capabilities of the HP 9000 Model 850S and industry-standard HP-UX operating system meet the needs of network management and message switching applications. The HP 9000 Model 850S is also a good choice for oil and gas, and software development environments.

The HP 9000 Model 850S is an excellent fit for customers requiring high speed, high performance, large memory expandability (up to 128 Mbytes), and large I/O bandwidth. At introduction, the HP 9000 Model 850S will support 90 users, with expandability to support a significantly higher number of users planned for the future.

System processing unit

Utilizing HP's NMOS III VLSI technology, the HP 9000 Model 850S improves hardware reliability by implementing the entire CPU on a single board. A single board includes the processor, the Translation Lookaside Buffer (TLB), 128 Kbytes of cache memory, and floating point coprocessor.

Operating at a clock rate of 27.5 MHz, the CPU is able to perform at a base instruction cycle time of 73 nanoseconds. With its floating point coprocessor, the HP 9000 Model 850S performs floating point calculations at a speed of 2.9 million double precision WHETSTONES per second. The large cache, 220-Mbyte per-second System Memory Bus, instruction pipeline, and optimized software compilers contribute to the HP 9000 Model 850S's superior performance.

The HP 9000 Model 850S comes standard with 16 Mbytes of ECC memory, two channel adapters, an HP-IB card, a 6-channel multiplexer, access port, 32-user HP-UX license, and battery backup support for up to 15 minutes.

Family compatibility

The HP 9000 Model 850S is object code compatible with the other members of the Series 800 family, making application migration simple and fast. This smooth migration path demonstrates HP's promise of protecting our

HP Precision Architecture/HP-UX

INTRODUCING THE HP 9000 MODEL 825S SUPERMINICOMPUTER

The HP 9000 Model 825S is the second HP-UX product resulting from HP's Precision Architecture (Spectrum) program. The introduction of the HP 9000 Model 825S comes just one year after the introduction of the flagship HP 9000 Series 800 product, the HP 9000 Model 840. The HP 9000 line of HP-UX systems now includes the Models 318, 330, 350, 825, 840, and 850 (also newly announced), giving users a broad range of HP-UX systems from which to choose.

The HP 9000 Model 825S is positioned as a multipurpose superminicomputer with broad applicability and is particularly well suited for scientific, software development, communications, oil and gas, industrial automation, real-time data acquisition, and

customers' current investments in HP hardware and software.

Ordering information

The HP 9000 Model 850S SPU will appear on the June 1 HP Price List. To order your HP 9000 Model 850S, refer to the table below:

Product No.	Description
9742A	HP 9000 Model 850S SPU <i>Hardware:</i> Model 850S processor, floating point coprocessor, 16 Mbytes main memory, 2 channel adapters, access port, 1 HP-IB, 1 6-channel multiplexer, power supply, 7-bay 1 meter cabinet <i>Software:</i> 32-user HP-UX license, C XDB, Assembler, DIL, real-time extensions, PORT/HP-UX <i>Other:</i> hardware and software documentation, site preparation consultation, on-site installation assistance, YO-day on-site warranty.
Opt. 516	Add 16-Mbyte main memory
<i>New add-on hardware</i>	
A1101A	CIO channel adapter
A1104A	16-Mbyte memory board

UNIX® is a registered trademark of AT&T in the U.S. and other countries.

communications applications. A sister product based on the same processor, the HP 9000 Model 825SRX, includes a high-speed, 3D bit-mapped graphics subsystem and is targeted chiefly for 3D solids modeling applications.

Because the HP 9000 Model 825S is based on HP Precision Architecture, it offers outstanding price/performance, low cost of ownership, high reliability, environmental tolerance, and provides lasting value for HP customers.

The HP 9000 Model 825 SPU

The HP 9000 Model 825S is based on a two-board processor that includes an NMOS III CPU chip, floating-point

chip set, 16 Kbytes of cache memory, a 2048 entry Translation Lookaside Buffer (TLB), and bus interface logic. As with all HP Precision Architecture processors, the instruction set is hardwired (no microcode) for extremely fast instruction execution. The HP 9000 Model 825S implements a three-stage pipeline and has a CPU cycle time of 80 nanoseconds.

The HP 9000 Model 825 is much more compact than any machine in its performance class making it much more flexible to configure. The processor is housed in a 234 x 235 x 500 mm package and can be rack mounted or placed on a desk.

The HP 9000 Model 825S comes standard with 8 Mbytes of error-correcting memory, expandable to 56 Mbytes in 2- or 8-Mbyte increments. Also included in the HP 9000 Model 825S are a 6-channel multiplexer, an HP-IB card, and a 16-user HP-UX license. Powerfail/Battery Backup is optional to preserve machine state in the event of AC power loss. With this option, if power is lost, full memory (56 Mbytes) is supported for a minimum of 15 minutes, and when power is restored, HP-UX is resumed without data loss.

HP Precision Architecture provides lasting value

HP Precision Architecture forms the foundation for the HP 9000 Series 800 systems. HP Precision Architecture goes beyond Reduced Instruction Set Computing (RISC) concepts to provide lasting value to users.

The reduced complexity of HP Precision Architecture results in significant price/performance advantages, simpler packaging, higher reliability, and lower cost of ownership. In addition to basic RISC principles like hardwired instructions, simplified addressing schemes, and single-cycle execution, HP Precision Architecture includes vast virtual-address space (the HP 9000 Series 800

has 48-bit virtual addressing) to facilitate very large program development, precise interrupting mechanisms, optimizing compilers, provisions for attached processors and coprocessors, and a scalable memory-mapped I/O system.

Setting new standards in the industry

Table 1 illustrates the HP 9000 Model 825S price/performance advantages over DEC, Data General, and IBM machines and Table 2 illustrates the other HP 9000 Model 825S advantages made available through HP Precision Architecture.

	HP 9000 Model/825S	DEC 8250	DG 15000/8	IBM 9375160
<i>Performance</i>				
MIPS	3.1	1.2	2.9	1.3
Kflops*	537	216**	N/A	460
Base Price (U.S. list)	\$42,500	\$65,000	\$57,000	\$93,000
<i>Price/Performance</i>				
\$/MIP	14	54	20	72
\$/Kflop	79	301		202

Table 1

*Based on the double precision Linpack benchmark

**Estimate based on DIGITAL stated performance figures

HP Precision Architecture/HP-UX

HP 9000 MODEL 825SRX SUPERWORKSTATION INTRODUCED

May 21, 1987, saw the introduction of our first superworkstation, the HP 9000 Model 825SRX (P/N A1005A). A superworkstation combines high-performance graphics with high computational performance to make complex design possible on a local system. The HP 9000 Model 825SRX is aimed at the 3D CAD market - with features, performance, and software tuned to that area.

The HP 9000 Model 825SRX performs integer calculations at 8.2 times the speed of the DEC VAX 111780 and

Environmental/ packaging	HP 9000 Model 825S	MicroVAX II (Floorstand)	VAX 8250
Size (sq. cm)	1,625	2,310	4,364
Operating temperature (C)	0-55	15-32	15-32
Operating relative humidity (non- condensing)	5-95%	20-80%	20-80%
Maximum power consumption (W)	600	690	1,400

Table 2

Ordering information

Product No.	Description
A1004A	<p>HP 9000 Model 825 computer includes:</p> <p><i>Hardware:</i> Model 825 SPU, floating point, 8-Mbytes main memory, one HP-IB card, one 6-channel multiplexer.</p> <p><i>Software:</i> HP-UX 16-user license, C, XDB, Assembler, DIL, real-time package, Port/HP-UX.</p> <p><i>Other:</i> installation and manuals.</p>
Opt. 001	Add 2-Mbytes ECC memory
Opt. 002	Add 8-Mbytes ECC memory
Opt. 003	Add seven CIO slots via I/O expander
Opt. 0E1	Add battery backup system



at twice the speed of the HP 9000 Model 350. For many users this means that the HP 9000 Model 825SRX becomes a viable alternative to main-frame-based design systems. The user gains the capability to perform detailed

designs and simulations on the same system. Interactive design becomes a reality, thus allowing complex designs to be completed faster and with fewer design errors.

Other application areas include: architectural engineering and construction (AEC), molecular modeling, mapping, and general-purpose graphics. In these areas, value-added businesses application software and user-written software will dominate.

The HP 9000 Model 825SRX expands the HP workstation family to the superworkstation level while maintaining source-code compatibility with HP 9000 Series 300 systems. The graphics system is the same as that used on the HP 9000 Model 350SRX. We now offer the widest range of engineering systems – from the HP Vectra PC, through workstations and superworkstations, to superminis.

The standard HP 9000 Model 825SRX includes the SPU with 8 Mbytes of ECC RAM, the SRX graphics subsystem including a 19-inch, 1280 x 1024 color monitor, LAN and ARPA/Berkeley networking, X-Window, Starbase, Workstation HP-UX, keyboard, and mouse.

HP Precision Architecture/HP-UX

HP 9000 MODEL 840S – DOUBLE THE TERMINALS, FOUR TIMES THE MEMORY

The HP 9000 Model 840S – initially introduced last year as the HP 9000 Model 840, the first HP-UX Precision Architecture system – is now more attractive than ever as a midrange superminicomputer offering. An I/O expander doubles the maximum number of terminal connections from 64 to 128. Maximum memory has been increased from the current 24 Mbytes to 96 Mbytes, quadrupling its memory capacity.

Increased terminal connectivity

The HP 9000 Model 840S I/O Expander allows an additional CIO channel to be added, increasing the number of I/O slots from 12 to 28. The expander slots can be used for any supported CIO cards, with the exception of the LAN card, increasing the number of supported users to 128.

The expander, orderable either as an option (P/N 9741A Opt. 601) or an add-on (P/N 19746B) to the system, includes the following:

- 16-slot I/O expansion module
- Power distribution unit
- External control panel
- CIO channel adapter and buffer card
- One-meter Model 840S cabinet

The I/O expander ties into the HP 9000 Model 840S Central System Bus, effectively increasing the CIO bandwidth by 5 Mbytes/second. This is an additional advantage for applications that require high throughput, such as monitoring switching systems in telecommunications.

Greater memory expandability

The memory capacity of the HP 9000 Model 840S has been increased from 24

Mbytes to 96 Mbytes, with the addition of a new memory product. The original 8 Mbyte set (PIN 19748A) consists of two cards that utilize 256-Kbyte NMOS dynamic RAM chips. The new 32-Mbyte set (PIN 19733A) uses 1-Mbit dynamic RAMs. Due to restrictions in the card slot positions, the possible memory configurations on the HP 9000 Model 840S are 8, 16, 32, 40, 48, 64, 72, and 96 Mbytes.

Additionally, HP is offering an attractive 8- to 32-Mbyte upgrade in order to give the user maximum choice on their memory configuration.

Better than ever

With the above enhancements, the HP 9000 Model 840S is more competitive in the scientific, software development, communications, oil and gas, and industrial automation marketplaces. The HP 9000 Model 840S also supports the 3D bit-mapped graphics available on the new HP 9000 Model 825SRX for those demanding graphics applications. The HP 9000 Model 840S is even more attractive when considering HP Precision Architecture benefits such as outstanding price/performance, industry-standard software including the UNIX® operating system, low cost of ownership, and environmental tolerance. And with the new HP 9000 Model 850S high-end supermini, an upgrade path is available for future computing needs.

Ordering information

The HP 9000 Model 840S is shippable immediately. The I/O Expander and



new memory product appear on the June 1 HP Price List.

Product No.	Description
9741A	HP 9000 Model 840S SPU <i>Hardware:</i> Model 840S processor, floating point coprocessor, 8 Mbytes main memory, channel adapter, access port, one HP-IB, one 6-channel multiplexer, cabinet. <i>Software:</i> 16-user HP-UX license, C, XDB, Assembler, DIL, real-time extensions, PORT/HP-UX <i>Other:</i> Installation and manuals.
Opt. 501	Add 8-Mbyte RAM
Opt. 502	Replace 8-Mbyte RAM with 32-Mbyte RAM
Opt. 503	Add 32-Mbyte RAM
Opt. 601	Model 840S I/O Expander
<i>New add-on hardware</i>	
10748A	8-Mbyte RAM
19733A	32-Mbyte RAM
19746B	Model 840S I/O Expander

UNIX[®] is a registered trademark of AT&T in the U.S. and other countries.

HP Precision Architecture/HP-UX

INTRODUCING NETWORKING

PRODUCTS ON THE HP 9000 MODELS 825 AND 850

The HP NS/9000 Series 800, LAN19000 Series 800, ARPA Services/800, and HP-UX Gateway/SNA3270 products will be available in fall 1987, for the HP 9000 Models 825 and 850. These products provide uniform networking services on all the HP 9000 Series 800 systems.

The HP 9000 Series 800 can be networked, via these networking services,

to other HP-UX-based HP 9000 systems, HP 1000 A-Series, MPE V-based HP 3000 systems, the HP Vectra PC, and other-vendor computers.

In a future introduction, Network File System (NFS) will be available on the HP 9000 Series 800. NFS is an emerging industry standard for remote file access across a common network.

These high-performance and user-friendly networking capabilities are provided over the high-speed, 10 Mbps IEEE 802.3 Standard Local Area Network (LAN) link, or the Ethernet LAN link as noted in Figures 1 and 2.

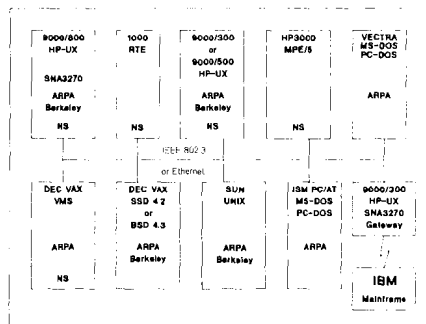

Figure 1. Series 800 in multivendor environment.

The networking services available to each computer are specified in each box. Computers on the network must have like services to communicate. (IBM services that are available to other HP computers are not shown.)

HP NS/9000 Series 800 and ARPA Services/800 – which includes ARPA and Berkeley services – require the HP LAN/9000 Series 800 product for access to the LAN. The NS, ARPA, and Berkeley services provide the right networking services to meet the needs of three different user environments: ARPA services network computers from vendors running different operating systems; Berkeley services network computers from vendors running the UNIX[®] operating system; and NS services network the HP 9000 Series 800 to HP-UX based HP 9000s, HP 1000 A-Series systems, MPE V-based HP

3000s, and DEC VAX/VMS systems. Refer to Figure 2 for the OSI correspondence, the architecture, and the product structure.

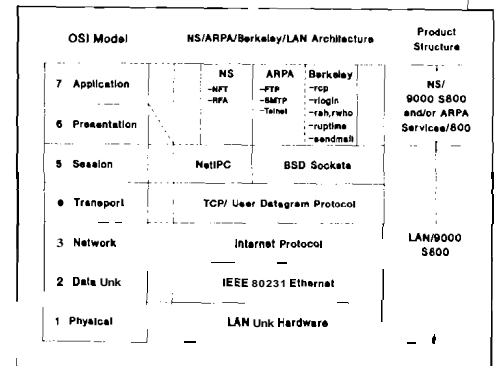

Figure 2. Series 800 NS/ARPA/Berkeley Services and the OSI/ISO Model.

HP LAN/9000 Series 800 is a high-performance, user-friendly networking product based on OSI layers one through five, supporting TCP/IP and UDP/IP as well as IEEE 802.3 and Ethernet. HP LAN19000 Series 800 supports HP's AdvanceNet Networking Services (NS/9000 Series 800) and industry-standard ARPA and Berkeley services (ARPA Services/800). The HP LAN/9000 Series 800 comes standard with a complete link connection to the local area network coaxial cable, and has diagnostic tools, industry-standard protocols (such as TCPIIP), as well as access to programmatic system calls (NetIPC and BSD sockets) used in interprocess communication. (Use of NetIPC may require NS services.) NetIPC between the HP 9000 Series 800 and the HP 1000 A-Series will be introduced in this release.

HP NS/9000 Series 800 is based on the HP AdvanceNet data communications architecture, and represents layer seven in the ISO/OSI Reference Model. HP NS/9000 Series 800 supports two network services – Network File Transfer (NFT) and Remote File Access (RFA) over the high-speed IEEE 802.3 local area network (HP LAN19000 Series 800) link. NFT between the HP 9000 Series 800 and the HP 3000 will be introduced in the late fall release. (See Table 1 for the exact services available between systems, and refer to the last section in this article for a

description of different networking services.)

Summary of HP 9000 Series 800 networking to other HP processors

Service	HP 1000	HP 9000	HP 9000	HP 9000	HP 3000
	A-Series NS and 802.3	Series 300 HP-UX NS and 802.3	Series 500 HP-UX NS and 802.3	Series 800 HP-UX NS and 802.3	MPE v NS and 802.3
File Transfer	NFT	NFT	NFT	NFT	NFT
Inter-process communication	NetIPC			NetIPC	
Remote file access		RFA	RFA	RFA	

Table 1.

Note: ARPA can be used to access the HP 9000 Series 300, 500, and 800, and HP Vectra PC, while Berkeley services can be used with the HP 9000 Series 300, 500, and 800.

ARPA Services/800 encompasses two types of services: ARPA and Berkeley. These services are provided over the EtherNet LAN only. (Refer to Table 2 for the specific services available between systems). ARPA services can be used to communicate with the HP 9000 Series 300, 500, 800, HP Vectra PC, other-vendor computers supporting ARPA, and computers on ARPANET or the Defense Data Network through ARPA gateways. Berkeley services can be used to communicate with UNIX® operating system computers such as the DEC VAX BSD 4.2/4.3 or SUN UNIX.

In order to use ARPA services from the HP 9000 Series 800 to the HP 9000 Series 500, HP Vectra PC, IBM PC/AT, and DEC VAXs, third-party ARPA products are required for those processors. The HP 9000 Series 500 requires Wollongong's WIN/H9000. The HP Vectra PC and the IBM PC-AT require the NRC Fusion Network Software Version 3.13 networking system (PIN FNS-PC-TCP). The DEC VAX with VMS requires Wollongong's WIN/VX Version 2.2.

HP-UX Gateway/SNA 3270 allows interactive communications between an HP 9000 Series 800 and an IBM System/370-compatible mainframe using SNA 3270 protocols. The HP 9000

Series 800 communicates to IBM through a nondedicated HP 9000 Series 300 gateway. HP-UX Gateway/SNA 3270 allows HP terminals, monitors, and printers on the HP 9000 Series 800 to emulate IBM 3278 terminals and 3287 printers. It also permits file transfers and multiple session capabilities. File transfers require that IBM's PC File Transfer programs be loaded on the host.

NS for the DEC VAX computer implements HP's AdvanceNet Network File Transfer (NFT) service over an IEEE 802.3 LAN to the DEC VAX/VMS family of minicomputers. This service allows for direct file transfer from the HP 9000 Series 800 to a DEC VAX. NS can coexist with DECnet on the same EtherNet/802.3 cable and can share the same hardware controller.

Summary of multivendor networking for the HP 9000 Series 800

Service	ARPA and EtherNet	Berkeley and EtherNet	Gateway/SNA3270 and NS and 802.3	NS for DEC VAX and NS and 802.3
Electronic mail	simple mail transfer protocol (SMTP)	sendmail (uses SMTP)		
File transfer	file transfer protocol (FTP)	remote copy (rcp)	3270 PC File Xfer	NFT
Inter-process communication		sockets		
Remote command execution		remote execution (remsh)		
Network virtual terminal	teletype network (TELNET)	remote login (rlogin)	3274/8 Pass-through	
Miscellaneous utilities		who, ruptime		

Table 2.

Network service description

This section describes several different networking services.

- **Electronic mail** – lets users send and receive mail to and from other users on the same system or on a remote system. There are a variety of electronic mail features that may not be included in an implementation of this networking service, so this feature should be compared with the alternative of a sophisticated

electronic mail application that runs under a system's operating system.

- **File transfer** – provides interactive and sometimes programmatic exchange of files to and from a remote system.
- **Inter-process communication** – allows programs running on different systems to exchange data through a set of programmatic calls. This service is important for developing distributed applications.
- **Remote command execution** – allows a user to send commands to a remote system for execution. With the UNIX operating system, this service allows the user to start a remote shell. This service can be used to start a program on a remote system, for automated processing, or for computational server applications.
- **Remote file access** – allows a user to use system commands to access directories and files resident on a remote system. This service is distinct from file transfer in that the file remains on the remote system. For instance, the user can open, close, read, or write to these files.

- **Network virtual terminal** – enables a user's terminal that is attached to a local system to appear as if it had a direct connection to a remote system. This capability allows interactive execution of programs residing on a remote system. For IBM terminal access, IBM 3274/8 Pass-through enables the HP asynchronous terminal to behave as if it were a 3278 terminal that is coax attached to a 3274 controller. This capability requires both terminal emulation and terminal access.

Configuration and ordering

The prices for HP NS/9000 Series 800, HP LAN/9000 Series 800, ARPA Services/800, and HP-UX Gateway/SNA3270 are on the June HP Price List.

For configuration and ordering details, refer to the June 1987 edition of

the HP 9000 Series 800 System Reference Guide, section 5.10. NS, ARPA, LAN, and HP-UX Gateway/SNA3270 for the HP 9000 Models 825 and 850 are being introduced in June, and will be available in the fall for the HP 9000 Model 825, and in late fall for the HP 9000 Model 850.

Product No.	Description
	HP-UX Gateway/SNA3270
36918A/R	For HP 9000 Model 825
36911A/R	For HP 9000 Model 840
36919A/R	For HP 9000 Model 850
	ARPA Services1800
50981A/R	For HP 9000 Model 825
50980A/R	For HP 9000 Model 840
50982A/R	For HP 9000 Model 850
	HP LAN/9000 Series 800
91786A	For HP 9000 Model 825
98194A	For HP 9000 Model 840
91788A	For HP 9000 Model 850
	HP NS/9000 Series 800
91787A/R	For HP 9000 Model 825
98195A/R	For HP 9000 Model 840
91789A/R	For HP 9000 Model 850

HP Precision Architecture/HP-UX

NEW NATIVE LANGUAGE I/O PRODUCTS FOR HP 9000 SERIES 800

The most recent release of HP-UX for the HP 9000 Series 800 brings new capabilities to the Native Language Support (NLS) product. These new HP 9000 Series 800 products reflect capabilities that exist on HP 9000 Series 300 HP-UX systems.

With the previous revision of HP 9000 Series 800 HP-UX, NLS software to support Japanese was included with the operating system. With the latest release of HP-UX, the Japanese NLS capabilities have been broken out into separate products so that users can purchase only the pieces they require.

The new NLS products for Japanese users are listed below.

Product No.	Description
92439A	Native Language I/O and Stick Kanji Font
92433A	Simplex Kanji Font

The 92439A product includes the basic Kanji font and necessary I/O software to allow Japanese customers to use the HP Asian Vectra PC and 41063A as peripherals. The 92433A Simplex Kanji Font is an enhanced Kanji font for the 92439A product.

These new products offer a wide variety of capability for Japanese users who wish to purchase only the functionality they desire.

HP Precision Architecture/HP-UX

HP 9000 SERIES 800 UPGRADE PROGRAM EXPANDED AND IMPROVED

Effective July 1, the HP 9000 Series 800 Upgrade Program has been expanded to include upgrades from the HP 1000 EIF and A-Series, and HP 9000 Series 500 to the HP 9000 Model 825S and upgrades within the Series 800 family. In addition, users can now receive 100 percent software upgrade credits when upgrading from the HP 9000 Series 500.

Program highlights

- 100 percent software upgrade credits
- Attractive upgrade incentives for SPU's, memory, and I/O cards
 - HP 9000 Series 800 upgrades: Model 825S to 840S, Model 825S to 850S, and Model 840S to 850S.
 - HP 1000 EIF and A-Series upgrades to HP 9000 Model 825S or 840S
 - HP 9000 Series 500 upgrades to Model 825S or 840S

▪ July 1, 1987, HP Price List

▪ Upgrades will be available to users until December 1988. At that time, the program will be evaluated for continuance.

Pricing may be reevaluated in December 1987.

Leverage new sales from HP's installed base of HP 1000s and HP 9000 Series 500s

The huge installed base of HP 1000s (over 100,000) and HP 9000 Series 500s represents a tremendous opportunity to generate incremental sales by upgrading users to the HP 9000 Series 800 product family. The upgrade program is an integral part of a strong, comprehensive migration program HP is offering to users. These programs and an extremely attractive family of HP 9000 Series 800 products combine to give you a powerful tool to leverage new HP 9000 Series 800 sales from our current installed base.

Target users

The HP 9000 Series 800 upgrade program is primarily aimed at users who have owned HP 1000 or HP 9000 Series 500 systems for two or more years. The best candidates are users who have outgrown their current systems and need more power or larger configurations. HP 1000 A900, F-Series, and HP 9000 Model 5501560 systems running computationally intensive applications or supporting more than 15 users are good potential targets. HP 1000 users with real-time critical applications or with specialized I/O cards may not be good candidates for upgrades since the HP 9000 Series 800 may not meet their application requirements. HP 9000 Series 500 users running Rocky Mountain BASIC, SRM, or RJE are also not good targets for upgrades since these applications are not supported on the HP 9000 Series 800.

100 percent software credit is a major selling point. It can substantially

increase the upgrade incentive for users with multiple software products. Other incentives to upgrade are higher performance, low cost of ownership, software compatibility across the HP 9000 Series 800 family, and access to future HP 9000 Series 800 enhancements, to name a few.

Where to get more information

Pricing and ordering information (with easy-to-follow examples) is available from your HP sales rep.

HP Precision Architecture/HP-UX

NEW PERIPHERALS SUPPORTED ON THE HP 9000 SERIES 800

With the upcoming release of HP-UX 1.1, support for the following new peripherals has been made possible:

- Printers: HP 2227A, 2228A, 2235A, 2684A, 3630A, and 41063A
- Terminals: Asian PC

Graphics devices: HP 7595A, 7596A, Renaissance

HP-UX Release 1.1 will continue to support all the peripherals currently available under HP-UX Release 1.0. Hence, all the peripherals currently supported under HP-UX 1.0, along with the new peripherals mentioned above, will be available on the HP 9000 Models 825S and 840S.

HP-UX Release 1.2 is expected to support additional new peripherals over those supported under HP-UX Release 1.1. These peripherals will be announced later. While the HP 9000 Model 850S will begin shipping concurrently with the release of HP-UX 1.2, the Model 825S and Model 840S will upgrade to HP-UX Release 1.2 as soon as it is available. Hence, all the HP 9000 Series 800 processors will be supporting all the peripherals available under HP-UX Release 1.1 along with any additional peripherals announced

with Release 1.2. The only exception to this is Renaissance, which is currently not planned to be supported on the HP 9000 Model 850S.

HP Precision Architecture/HP-UX

CORRECTION:

DISTRIBUTION OF RMTERM/HP-UX

CONTRIBUTED LIBRARY TAPE

On page 6 of the April issue of *HP Channels*, it was stated that the Contributed Library Tape containing the RMTERM Application Note and Software would ship with HP-UX. As of now, the RMTERMIHP-UX Contributed Library Tape will **not** be shipped free of charge.

RMTERM remains part of the HP Precision Architecture Contributed Library Tape but the tape will **not** ship as part of every system. The Contributed Library Tape will be orderable separately. Every effort is being made by the HP-UX Product Marketing Team to define ordering details. We are reviewing the mechanism of delivery for this product and we will notify users when the decision has been made. Watch this publication for complete HP-UX Contributed Library ordering and delivery information.

Meanwhile, RMTERM remains available in the *A-Series Computer Handbook for System Designers and OEMs*, PIN 5954-8555, orderable from your HP sales rep. Both the Application Note and Source Code Listing are included in this publication.

HP 9000

HP ADDS NEW 2D GRAPHIC SUBSYSTEM TO HP 9000 MODEL 350

A new HP 9000 color workstation has been introduced by Hewlett-Packard that adds high-performance two-dimensional graphics capability to the graphics-workstation offering. The HP 9000 Model 350CH 2D graphics workstation provides state-of-the-art performance for the most demanding applications with a true 32-bit processor, the 25 MHz Motorola 68020.

HP is committed to assisting OEMs and software vendors in the development and porting of applications to the HP 9000 Model 350CH. The workstation is well-suited for the advanced design requirements of design engineers in electrical, mechanical, and software engineering, including such computation-intensive tasks as logic simulation and printed circuit board routing.

The HP 9000 Model 350CH is furnished complete with the 68020 CPU; 68881 floating point co-processor; 8 Mbytes of RAM (expandable to 32); four gigabytes of virtual memory address space; 32-bit bus system; 32-bit I/O bus; IEEE-488 disc interface; two-channel disc memory access controller; and HP-HIL, HP-IB and RS-232 interfaces. HP 9000 Model 350CH comes standard with a 19-inch color monitor with an option to choose a 16-inch monitor.

The new graphics display subsystem that is included with the HP 9000 Model 350CH provides 1280 × 1024 resolution, 8-color planes, two overlay planes and two times the vector performance of the previous 2D color workstation, the HP 9000 Model 350C.

The HP 9000 Model 350CH features provide several benefits to the engineer

using 2D applications for increased productivity:

Feature	Benefit
1280 x 1024 resolution	More accurate graphical representation of images
8 color planes provide 256 colors from a palette of over 16 million and double-buffering	Clear definition of images and smooth movement of complex images
2 overlay planes	Easier to write applications because you have separate planes for cursor tracking and additional off-screen image storage for menus or windows
Hardware support of vectors, polygons, pixel replication area fill, and stippling	Interactivity speeds processing time
Bit-per-pixel addressing	Lowers cost of system and improves productivity by reducing the amount of RAM needed, transferring images faster, and improving menu performance.
Compatible with HP 9000 graphics workstations	Simplifies and speeds the porting of application!

The new graphics subsystem featured in the HP 9000 Model 350CH workstation is also available as a stand-alone display board that can be added to an existing HP 9000 Model 320, 330, or 350 workstation. The product number is 98550A.

The optional 16-inch monitor (PIN 98789A) provides 80 percent of the display surface area in 50 percent of the volume of the 19-inch monitor while maintaining the 1280 x 1024 resolution.

HP will also be offering a 2D integer-based graphics accelerator which may be connected to the graphics display system. It will be available late this year. The graphics accelerator will provide a world coordinate interface for 2D integer applications that require

very high performance graphics in operations such as real-time pan and zoom. It provides between a 10 and 15 times improvement in world coordinate vector performance. Applications such as VLSI and PCB design would benefit the most from the addition of the accelerator.

The HP 9000 Model 350CH (PIN 98588A) is U.S. list priced at \$39,400.

HP 9000

HP 9000 SERIES 300 HP-UX RELEASE 5.3 AND 32-USER PRODUCT

The next release of HP-UX for the HP 9000 Series 300 is expected in the May-June timeframe. It will be primarily a bug-fix release. Coming at the same time will be a 32-user product for the HP 9000 Series 300. The product structure is shown below:

Product No.	Description
98596A	HP 0000 Series 300 HP-UX 32-user AXE
Opt. 022	Software on 5/8-inch tape
Opt. 003	16- to 32-user upgrade
Opt. 100	Delete manuals

Note that this product is offered on tape *only*. To go from the single-user AXE to the 32-user product requires purchasing the single- to 16-user upgrade and then the 16- to 32-user upgrade. An alternative is to purchase the 32-user product as the cost is the same. The multiuser Programming Environment will work on either the 16- or 32-user AXE products.

Performance data indicates that the HP 9000 Model 350 can support 32 users with very good performance in a FORTRAN development environment. The data also shows excellent performance with up to 24 users.

The HP 9000 Models 320 and 330 will probably provide adequate performance under certain circumstances for more than 16 users. Performance data on these systems is currently being run. The 32-user license is *not* supported on the HP 9000 Model 310. The processor in a Model 310 is the 68010, while the other models have the 68020. There are sufficient differences in HP-UX running on these processors to make more than 16 users not feasible on the Model 310. To configure more than 16 users might make the HP 9000 Model 310 unbootable.

HP 9000

NEW RELEASE OF HP TODAY

HP's Australian Software Operation (ASO) is pleased to announce the new release of HPtoday, orderable now on normal shipment schedules.

HPtoday is Hewlett-Packard's strategic application development environment under HP-UX*, particularly suited to efficient development of transaction-based applications. Quite a different concept from a conventional, third-generation language. HPtoday even goes beyond the usual ideas of a fourth-generation language. It provides a fully integrated environment, including system administration and application testing, and requires no separate editors, compilers, etc.

Instead of cutting reams of code, the programmer designs an application by defining individual elements, such as a screen form, a report, a menu, or a set of function keys. Definitions are completed on formatted input screens, with on-line help always related to the current action. More information about HPtoday's method of application development is included in the data

sheet (PIN 5954-6325), available through your HP sales rep.

HPtoday has always included the C-ISAM data manager. Added in the new Release A.01, is an HP-SQL standard interface to the HP Allbase database manager. Now applications can be rapidly developed that incorporate relational database access. For example, user-friendly front ends for inexperienced computer users are particularly attractive to develop.

Several other enhancements are included in Release A.01. Some of these provide the most-requested enhancements needed to achieve application compatibility between HPtoday and the TODAY product, available worldwide from BBJ International Limited and its distributors. TODAY operates on a wide variety of UNIX® operating system and proprietary systems.

Highly significant are the performance improvements achieved since the first release of the product a year ago. Based on a nightly suite of over 700 application tests, we suggest that overall application performance should improve about three fold. Some areas, such as application loading and unloading, now run ten times faster. In recent specific tests, an HPtoday application was pitted against a matching application efficiently coded in COBOL. In the critical area of disc file handling, HPtoday was as fast as COBOL – in four out of the six tests, marginally faster (up to 8 percent).

Clearly, the latest release makes HPtoday even more attractive as a development system for transaction-based or data-intensive applications. Of course, its efficient EXTERNAL command, with full parameter passing both ways, allows you to develop friendly front ends for existing or specialized code in any language running under HP-UX. And with HPtoday, you can offer a truly scalable solution, since HPtoday applications run unchanged right across the HP 9000 family of

computers, including the HP 9000 Precision Architecture Series 800 computers.

It is this flexibility and productivity that have attracted customers worldwide, ranging from telecommunications and manufacturing industries to defense. Almost every customer needs rapid development of attractive applications for basic data handling and manipulation. With its prototyping techniques, HPtoday can give you a strong competitive appeal in this large market.

** HP-UX is Hewlett-Packard's System V compatible implementation of the UNIX® operating system.*

UNIX® is a registered trademark of AT&T in the U.S. and other countries.

HP 9000

EXPANDED FAMILY OF ME SOLUTIONS

HP is pleased to announce several additions to the Mechanical Engineering Series 5110130 CAD family. These products build upon the very successful ME Series 10 Design and Drafting system, and the new ME Series 30 Modeling, Design, and Drafting system. These additions expand the breadth of product family, and allow the ME Series 5110130 to exchange data with many other CAD, numerical control, and finite element systems.

AutoCAD to ME Series 10130 Translator

The AutoCAD™ to ME Series 10130 Translator allows CAD users who have been using the AutoCAD PC-based ME CAD software to upgrade to the workstation-based ME Series 10130 software. The translator will take AutoCAD's DXF format and convert it to the MI format of ME Series 10130. The user will then be able to bring drawings that were developed on the AutoCAD software into the ME Series

10130 software for modification, documentation, or solid modeling. With over 80,000 AutoCAD installations to date, this translator opens up a huge market of potential users – firms that have outgrown the limited capabilities of their PC-based system. The translator will allow them to make use of the advanced features of the ME Series 10130 product family without having to scrap their existing library of drawings.

ME Series 5 HP-UX

The ME Series 5 Drafting and Documentation system is now available in both the HP-UX and Pascal environments. Users can now use ME Series 30 (HP-UX only) for solid modeling and design, and pass the drawings over a LAN to a ME Series 5 station for final drafting and documentation. The easy-to-learn user interface has been designed specifically with drafters, technical illustrators, and engineers in mind. The powerful internal data structure, however, is the same as that in the ME Series 10 and the ME Series 30, with double-precision accuracy and advanced drafting capabilities.

IGES 3.0 Translator

The IGES 3.0 Translator allows drawings that have been created in other CAD systems to be translated to the ME Series 10130 products, and vice versa. The IGES (International Graphics Exchange Standard) format is a neutral file format that has been agreed to by most major CAD suppliers as a method to translate drawings from one CAD system to another. HP's IGES translator supports the majority of the two-dimensional IGES 3.0 specifications, and is fully compatible with IGES 1.0 and IGES 2.0. Therefore, firms that have been using another vendor's CAD software will be able to translate their drawings to the ME Series product family for further modeling, design, and drafting. This translator provides HP the opportunity to sell into accounts that are currently using

another vendor's CAD products and would like to switch to the ME Series product family, or into those accounts that do subcontracting for a firm that is using a different CAD system.

Finite Element Links

For users that have requirements for finite element modeling and analysis, the ME Series 30 provides links to the ANSYS, Femgen, and Patran finite element packages. Users can use the geometry created in ME Series 30 to model and analyze their designs using the finite element method before having a prototype built.

Numerical Control Links

The ME Series 30 provides output in the APT-AC, COMPACT 11, and GNC formats for those users who would like to drive numerically controlled machine tools with the geometry created by the ME Series 30. By using this geometry directly, there is less likelihood of error in creating the part, and a shorter turnaround time from design to manufacturing.

All the products listed above are currently on the HP Price List and available unless otherwise stated.

HP is pleased to announce this expanding family of products in the ME Series product line. For more information on the ME Series product family, please contact your local HP sales rep.

AutoCAD™ is a U.S. trademark of Autodesk, Inc.

HP 9000

ANNOUNCING

HP PCDS

REVISION 1.1

HP has announced the first software revision to the HP Printed Circuit Design System (HP PCDS). HP PCDS, an HP DesignCenter product, is a full-function, computer-aided-design (CAD) system for the design of printed circuit boards. Through the use of automatic and interactive tools, HP PCDS aids the user in ensuring design integrity and manufacturability of printed circuit boards.

Since its introduction in June 1986, over 150 design seats have been sold to both internal and external users. During this time, HP has been hard at work adding new features and removing defects. The result is Revision 1.1.

Better system performance

HP PCDS now supports new hardware recently introduced by many HP divisions, including workstations, disc drives, plotters, and graphics display systems. Now available to users are lower entry-level system costs, higher performance systems, greater data-storage capacity, faster and more reliable plotter output, and the ability to run both HP PCDS and ME-30 on the same workstation.

Specifically, HP PCDS now offers users support of:

- HP 9000 Series 330 and 350 workstations
- HP 7958A, 7936H, and 7937H disc drives
- HP 7570A, 7595A, and 7596A plotters
- HP 9000 Series 350SRX, 3-D graphics display system

Enhanced Surface Mount Technology (SMT)

HP PCDS has been enhanced significantly for surface mount technologies. Faster design times are achieved through new features that increase auto-router completion rates and through the addition of surface mount device parts that reduce the tedious task of library parts creation. In addition, added SMT spacing parameters help ensure PCB design integrity. Specifically, Revision 1.1 adds the following features:

- Swapping of parts between the sides of a PCB during the parts-placement improve procedure

- User-definable routing grid

SMT spacing parameters added

Addition of 300 surface mount parts (SMD).

Better performance, flexibility for automatic tools

Performance enhancements to the automatic tools result in higher, automatic board completion rates, saving users valuable design time. The automatic tools are much more flexible:

Single-pass execution of Auto-Improve-Device Placement speeds execution time

- Users can now stream together automatic place and improve sequences for scheduled "batch" processing during nondesign time
- User-specifiable routing grids to adapt routing strategies for particular needs
- The Autorouter adheres to user-specified design rules to ensure design integrity and high PCB manufacturing yields

Autorouter strategy editing much easier and more friendly

Front-end links easier to use

Many of you asked that the *link* between HP PCDS and the HP schematic capture system, HP Electronic Design System, be simplified. We took your advice and made it much more

user friendly. A Schematic Netlist Editor has also been added to HP PCDS to provide an easy-to-use, manual entry of netlist information into HP PCDS.

Improvements to the HP PCDS user-interface

To make the HP PCDS user-interface easier to use, faster, and more consistent, many small enhancements have been added. Many of these enhancements are the result of your requests:

- Function keys pick with cursor
- Optional, left-hand puck map
- Automatic work area generation when creating board blank
- Different markers now used to highlight different design rule violations
- DSM spooler now handles both HP PCDS and HP EDS plot files

For more detail on Revision 1.1 of HP PCDS contact your HP sales rep.

HP 9000

NEW HP PCDS

SYSTEM

CONFIGURATIONS

Revision 1.1 of HP PCDS now supports the new HP 9000 Series 330 and 350 workstations. These new workstations and the HP PCDS application software now offer users a superior price/performance family of PCB CAD systems.

Listed here are the four configurations recommended for use with HP PCDS. The entry-level system, based on the HP 9000 Series 330, is well suited for cost-conscious users. For most users, the high-performance system, based on the HP 9000 Series 350, is well suited. Those users requiring high-speed graphics performance should choose the high-performance graphics system, which includes a graphics accelerator and extra planes of graphics memory. Finally, those users looking for a server to offload their

autorouting jobs should choose the Autorouter Station.

Ordering information

Product No.	Description
<i>Entry-level system</i>	
98583L	Model 330C bundled system
Opt. 010	High-speed disc interface
7958A	131-Mbyte disc drive
9144A	1/4-inch cartridge tape drive
74400A	HP PCDS, complete software
<i>High-performance system</i>	
98583C	Model 350C bundled system
7936H	307-Mbyte disc drive
35401A	1/4-inch cartridge tape autochanger drive
46087A	HP-HIL, A-size graphics tablet
Opt. 001	Adds four-button cursor with crosshair
92211L	Taboret
74400A	HP PCDS, complete software
<i>High-performance graphics system</i>	
98586B	Model 350CX bundled system
7936H	307-Mbyte disc drive
35401A	1/4-inch cartridge tape autochanger drive
46087A	HP-HIL, A-size graphic; tablet
Opt. 001	Adds four-button cursor with crosshair
92211L	Taboret
74400A	HP PCDS, complete software
<i>Router station</i>	
98582C	Model 350M bundled system
7957A	80-Mbyte disc drive
92211L	Taboret
74402A	HP PCDS, autorouter software only

For complete information on configuration, ordering, and pricing, please contact your HP sales rep.

Also in this issue

SRM IIF Card for
HP Vectra PC

24

Personal Computers

General

WORDSTAR/ MAILMERGE TO BE OBSOLETE

On September 30, 1987, all non-English versions of WordStar™/Mail-Merge (PIN 45313A/B-Z) will be removed from the HP Price List.

Demand for the product has been declining steadily over the past few months. This situation is expected to continue, so the obsolescence plan will commence on October 1, 1987. The product will have a five-year support life.

For further information, contact your HP sales rep.

WordStar is a U.S. trademark of MicroPro International Corp.

Desktop

HP VECTRA 3000

PC: EVEN BETTER

WITH NEW HP

PRODUCTION

PLANNING/PC

When purchasing a Materials Requirement Planning (MRP) solution, the HP Vectra 3000 PC is the perfect workstation partner to the HP 3000 minicomputer. With the introduction of the new HP Production Planning/PC, HP now has an even more powerful solution to help HP Materials Manage-

ment (MM) users gain more productivity in their critical business tasks.

The HP Vectra 3000 PC provides the core workstation solution. Users can order a complete system with just one product number. Because it arrives pre-assembled, users can easily set up their new PCs and tie into the HP 3000.

The new HP Production Planning/PC offers a convenient link between HP Materials Management and 1-2-3® from Lotus®*. Users can bring critical data down to the personal computer for further analysis/manipulation or upload the new production plan back to MM. Production planners or master schedulers can also build models that fit their business needs, extract the required information from the minicomputer, and perform fast *what if* analyses on their production plans.

And remember HP's key strengths: PC integration and our ability to send, interpret, and exchange information across an organization. Production plans prepared in 1-2-3 from Lotus can be read directly into HP Graphics Gallery for impressive presentations. The planner can also create professional reports with Gallery illustrations in Executive MemoMaker, then distribute text or graphics via HP DeskManager – for improved communications and more informed decision making.

As of May 1, the new HP AdvanceLink (with graphics) will automatically be shipped with the HP Vectra 3000 PC.

**1-2-3 from Lotus must be ordered separately.*

1-2-3® and Lotus® are U.S. registered trademarks of Lotus Development Corporation.

Desktop

ANNOUNCING NEW HP ADVANCELINK FOR HP VECTRA PC

On May 1, HP introduced a new improved release of the popular HP AdvanceLink 2392 product. HP AdvanceLink now has new features and performance improvements including state-of-the-art data compression.

New terminal capabilities

HP 2627 color graphics terminal emulation on EGA systems

- HP 2623 monochrome graphics terminal emulation on systems other than EGA
- Up to 25 percent faster terminal emulation than before
- HP terminal standard 26-line display on all HP video systems except the Monochrome Plus

New file transfer capabilities

- State-of-the-art data compression algorithm for file transfer with the HP 3000
- Up to 500 percent faster file transfer with HP 3000 than before, typical increase will be 150-200 percent faster
- X.25 network transparency mode in file transfer with HP 3000 cuts the number of packets, time, and cost almost in half – you get additional savings when combined with data compression
- Comprehensive PC backup to the HP 3000, HP 1000, or HP 260 (with data compression to the HP 3000)
- MS DOS command and program access from HP AdvanceLink

HP AdvanceLink 2392 could have become HP AdvanceLink 23921262312627, but to keep things simple, we are now just calling it HP AdvanceLink. These new features are combined with the capabilities HP AdvanceLink has had all along,

HP 2392 and VT100 terminal emulation, HP AdvanceNet support, and an extensive command language. Now, more than ever before, HP AdvanceLink meets users' needs for a general-purpose PC data communications product.

Ordering information

Product No.	Description
68333F	HP AdvanceLink
68333-65001	Upgrade from HP AdvanceLink 2392

Desktop

HP VECTRA 3000

PC: MOST

FREQUENTLY ASKED

QUESTIONS

The price of the new HP AdvanceLink has increased from \$295 to \$325 (U.S. list). Has the price of the HP Vectra 3000 PC (which includes the new AdvanceLink) also increased?

No. So that you can continue to purchase the HP Vectra 3000 PC at the same price as before, we have increased the discount off the sum of the components price.

What are the advantages of the Monochrome Plus video subsystem, the new monochrome solution now bundled with the HP Vectra 3000 PC Monochrome?

The Monochrome Plus video solution combines three of the industry's most popular video standards and a parallel printer port on one card. It provides compatibility with the IBM Monochrome Display Adapter, Hercules Graphics Card, and IBM Color Graphics Adapter.

Unlike Multimode, which maps colors onto 16 shades of gray often with minimal contrast between different graphic areas, the Hercules graphics

standard is designed for high-resolution monochrome output. This results in maximum contrast and clarity in graphics applications such as 1-2-3[®] from Lotus[®], AutoCAD[™], and Graphics Gallery.

How many lines can I display on the screen of the HP Vectra 3000 PCP

On an EGA system with the new AdvanceLink (version B.00.01), 26 lines (24 for text, 2 for function keys) can be displayed. The EGA video standard has always had the capability to handle different fonts. Previously, however, HP AdvanceLink 2392 did not take advantage of this particular functionality of the EGA. Now it can. The new HP AdvanceLink downloads a character font that is one dot shorter than the standard EGA font previously used. The result is that 26 lines can be shown on the screen of the HP Vectra 3000 PC EGA.

On a Monochrome Plus system, 25 lines (23 for text, 2 for function keys) can be displayed. This is today's standard set by all IBM-compatible monochrome cards. Unlike EGA, IBM-compatible monochrome cards cannot handle different fonts. As a result, even the new HP AdvanceLink or Reflections 3 will not change the number of lines you see. However, it is possible to display 24 lines of text with 1 line for the function keys. See next question.

The Monochrome Plus video solution, being IBM-compatible, is capable of displaying 23 lines of text and 2 lines of function labels (25 lines total). How can the display be changed to 24 lines of text and 1 line of function labels? Which applications use the 24th line?

If you have a Monochrome Plus display, the default of 23 lines leaves you 2 lines for function labels. To change the HP AdvanceLink setting to 24 lines, go to the "Global Config" menu and change the field "Screen Size" to 24 lines. Once HP AdvanceLink is set for 24 lines of data plus 1 line of function keys, you can use the "F9" key to temporarily pop-up the function label to view the full 2 rows.

For example, HP 3000 block mode applications, like VPLUS, use 24 lines. If HP AdvanceLink is set to 24 lines, you may easily change the display to 23 or 24 lines by simply pressing the "F9" key. With a 24-line setting, abbreviated 1-line function labels will be displayed that are designed to be meaningful even in the I-line version. Switching back and forth between the 23 or 24 line display is quick and easy. Just press "F9."

	Default	Press "F9"
Lines for text display	23	24
Lines for function key display	2	1
Total lines available	25	25

What if a user still wants to purchase the Multimode video solution?

Users can order all the necessary components separately. The five components include:

Product No.	Description
72450.A	HP Vectra PC Model 50
45891A	Multimode video adapter
35731A	12-inch monochrome monitor
45951A	HP Vectra PC operating system (DOS 3.1)
68333F	HP AdvanceLink

AutoCAD[™] is a U.S. trademark of Autodesk, Inc.

1-2-3[®] from Lotus[®] is a U.S. registered trademark of Lotus Development Corporation.

Desktop

BUSINESS MANAGEMENT PORTFOLIO NOW PACKAGED WITH GALLERY COLLECTION

Since the release of The Gallery Collection for the HP Vectra PC and IBM PC/XT/AT and compatibles, users have

had to send in a coupon requesting that a Gallery Portfolio be mailed to them.

Now, the Business Management Portfolio – which includes symbols for the Gallery user in the areas of marketing, finance, sales, personnel, facilities management, quality assurance, and research and development – will be packaged with The Gallery Collection.

The price of this Portfolio is included in the overall price. This Gallery Portfolio also now includes a set of symbols specifically designed for the European market.

The Gallery Collection (PIN 68352F) includes the following:

Product No.	Description
68351F	Drawing Gallery
68350F	Charting Gallery
68326F	Business Management Portfolio*

** The only change to the current Collection product*

The other Gallery Portfolios are available separately:

Product No.	Description
68324F	Office Activities Portfolio
68325F	Chemical/Petrochemical Portfolio
68327F	HP Draw Figures Portfolio

The Gallery Collection has been an extremely popular product for users looking for an easy-to-use, complete business-graphics product that enables them to produce output for high-quality presentations.

And, *PC Magazine* voted Gallery #1 among other popular business graphics products.

Desktop

EUROPEAN SYMBOLS NOW AVAILABLE FOR GRAPHICS GALLERY

A set of 44 pictures has been added to the Business Management Portfolio, now packaged with The Gallery Collection and also orderable separately (P/N 68326F for the HP Vectra PC and PIN 45570A for the HP Touchscreen PC).

Included are 28 maps of European countries and regions along with symbols such as a train, scooter, and gondola. Some examples are shown below:

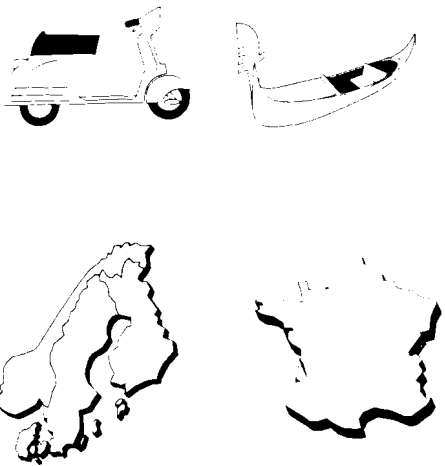

For those Gallery users who have already purchased the Business Management portfolio and would like the European pictures, please contact your HP sales rep.

Desktop

SRM I/F CARD FOR HP VECTRA PC

The new HP 50963A SRM interface card for the HP Vectra PC is now available (June 1 HP Price List). This allows BASIC and Pascal programs executing on the new Language Processor board (HP 82300A/82302A) on the HP Vectra PC to access the SRM Server over the SRM coax network exactly the same way programs do in HP 9000 Series 2001300 workstations.

Product description

The HP 50963A SRM interface card is electrically identical to the 50962A interface card for HP 9000 Series 2001300 computers, but is physically laid out on a PC/AT interface card format. It fits into an interface slot on the HP Vectra PC and only draws power from the HP Vectra PC backplane. It connects to the Language Processor board via ribbon cables that implement the DIO backplane. It has a coax BNC T connector on the faceplate for connection to the SRM coax network.

The software necessary to access SRM from the HP Vectra PC is built into the BASIC and Pascal operating systems that run on the Language Processor. BASIC and Pascal programs access SRM the same way they do on HP 9000 Series 2001300 systems. For example, they can easily copy files to and from SRM and a local hard disc or the internal disc of the HP Vectra PC.

Ease of adding systems

The benefit of this interface card is that it facilitates adding HP Vectra PC systems where HP 9000 Series 2001300 and SRM systems are installed. HP Vectra PC systems running BASIC and Pascal on the Language Processor can access the same SRM Server the installed HP 9000 Series 2001300 systems use. If an HP Vectra PC system with 'Rocky Mountain BASIC' is purchased as a starter system with the potential of adding additional HP 9000 Series 2001300 systems in the future.

SRM will facilitate connecting them together at that time.

SRM versus HP OfficeShare

If an SRM Server and network is already installed, then it is appropriate to use it as the Server for the BASIC and Pascal systems on the Language Processor.

If there are no other HP 9000 Series 2001300 systems or SRM installed now or in the near future and you are buying several HP Vectra PC systems with the Language Processor, you should buy the HP OfficeShare server (available with ThinLAN, StarLAN, or SERIAL network). Presumably, the reason you bought the HP Vectra PC instead of an HP 9000 Series 2001300 system is to utilize the many PC applications that run on DOS. These applications cannot easily access SRM. However, the BASIC and Pascal applications running on the Language Processor can easily access DOS discs, including the remote disc on the OfficeShare Server.

LAN gateway application

An HP Vectra PC equipped with the Language Processor can act as a gateway between the SRM network and various other networks. The SRM interface and the other network card would be installed on the HP Vectra PC. The appropriate DOS network software would run in the DOS environment. A simple 'spooler' program would run in BASIC or Pascal to retrieve files from the SRM disc and pass them to the DOS network software. This is a lower-cost and more easily managed solution than using an HP-UX system for this function.

Ordering information

Product No.	Description
50963A	SRM Interface

Desktop

ADVANCEWRITE/PAGEMAKER: THE PERFECT DTP SOLUTION

ADVANCEWRITE/PAGEMAKER

The Perfect D.T.P. Solution

ADVANCEWRITE: HEWLETT - PACKARD'S STRATEGIC WORD PROCESSOR INTEGRATES WITH INDUSTRY LEADING DTP PROGRAM. PAGEMAKER.

AdvanceWrite offers the functionality of a sophisticated word processing solution plus the versatility of integration with industry's leading Desktop Publishing program PageMaker.

DTP Solution

AdvanceWrite together with the Vectra Publisher PC (including PageMaker) and the HP LaserJet family of printers provides a versatile DTP solution.

Top Quality Results

Desktop Publishing lets you quickly create professional looking proposals, newsletters, brochures, flyers and other documents. It lets you ask "What if" by experimenting with different layouts and styles to produce top quality results.

Integration

By simply converting your AdvanceWrite text into DCA revisable format using the "file translate" function within AdvanceWrite, the most sophisticated of

AdvanceWrite documents can be integrated directly into PageMaker.

Saving your Graphic Gallery files in TIFF format will enable you to integrate AdvanceWrite text and graphics within PageMaker.

Target Market

Existing AdvanceWrite users are "prime candidates" for a DTP solution. By adding PageMaker and an

HP LaserJet Printer, top quality document creation is at their fingertips.

ORDERING INFORMATION

- AdvanceWrite II (27507F) - \$550
- AdvanceWrite III (27508F) - \$695
- HP Vectra Publisher PC monochrome Model 96 (72496A) - \$5829
- HP Vectra Publisher PC EGA Model 97 (72497A) - \$6719
- Aldus PageMaker for the PC from Hewlett Packard (45964A) - \$850

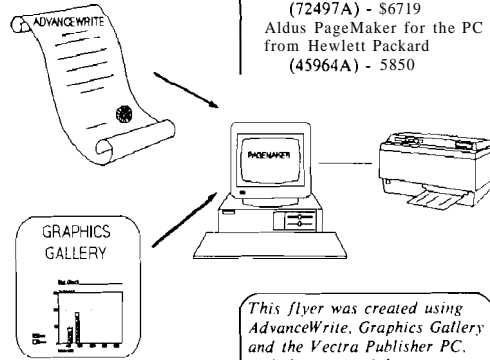

This flyer was created using AdvanceWrite, Graphics Gallery and the Vectra Publisher PC, including PageMaker.

PageMaker(R) is a registered trademark of Aldus Corporation

AdvanceWrite offers the functionality of a sophisticated word processor plus the versatility of integration with the industry's leading desktop publishing program, PageMaker®.

Use HP's desktop publishing solution, the HP Vectra Publisher PC, with AdvanceWrite II or III to create top-quality professional documents like the one shown in the illustration.

Some formatting is necessary when placing a converted AdvanceWrite DCA file within PageMaker. Limitations exist with paragraph indents, super and subscript, and centered and bold text. However, these can be easily rectified within PageMaker.

For more information on how AdvanceWrite integrates with Page-maker, contact your HP sales rep.

PageMaker® is a U.S. registered trademark of Aldus Corporation.

Desktop

LOCALIZED HP VECTRA PC OS

PRICE INCREASE - CORRECTION

The increases in factory base price (FBP) of localized HP Vectra PC Operating System (OS) Kits have been postponed from May 1, 1987, to July 1, 1987.

Products affected by this change are listed below.

Product No.	Description
HP 45951AD	German
HP 45951AE	European Spanish
HP 45951AF	French
HP 45951AH	Dutch
HP 45951AM	Latin American Spanish
HP 45951AN	Norwegian
HP 45951AP	Swiss-German
HP 45951AQ	Swiss-French
HP 45951AS	Swedish
HP 45951AU	United Kingdom
HP 45951AV	Arabic
HP 45951AW	Flemish
HP 45951AX	Finnish
HP 45951AY	Danish
HP 45951AZ	Italian

Contact your HP sales rep for pricing information.

Also in this issue

PC/Peripherals Self-Paced Mentored Training News

2

Peripherals

Mass Storage

HP 9133/34H

OBSOLESCENCE

REMINDER

The HP 9133/34D and HP 9133/34H were obsoleted effective May 1, 1987. Both products are replaced by the HP 9153/543B which became available on November 1, 1986.

In addition, the following products were also obsoleted effective March 1, 1987:

Product No.	Description
45807A	Brackets for mounting hard discs into HP Vectra PC
45808A	Hard disc-to-controller cable assemblies
45815A	ST 506 Controller
45815K	Disc Controller
45817M	40-Mbyte mechanism only

For additional information, contact your HP sales rep.

Mass Storage

HP 35401A: COST JUSTIFICATION

Many HP sales reps are finding that they can sell the HP 35401A 1/4-inch cartridge autochanger tape drive more effectively by presenting the cost considerations to the customer.

Currently two products are available from HP Computer Peripherals Bristol, the HP 35401A and the HP 9144A. The backup capacity of the products is 536 Mbytes for the HP 35401A and 67 Mbytes for the HP 9144A.

The ability of the HP 35401A to automatically select from eight cartridges provides high storage capacity

and gives the customer the benefit of operator cost savings. The savings may eventually equal the additional investment of the HP 35401A over the HP 9144A. The time to reach the break-even point (the justification period) will vary with the number of Mbytes that are being backed up, and also the operator cost.

The following graphs illustrate how these factors influence the justification period. In Diagram 1, the savings in operator cost equal the extra capital investment of purchasing the HP 35401A at the intersection points on the graph.

The larger the number of Mbytes and operator cost, the shorter the justification period.

Cost justification for purchasing an HP 35401 instead of an HP 9144

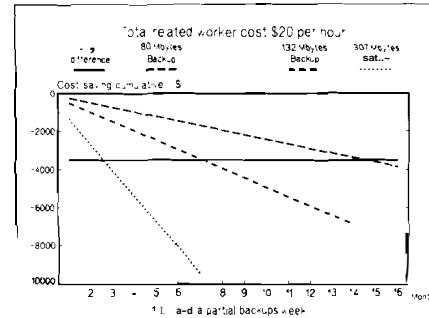

Diagram 1

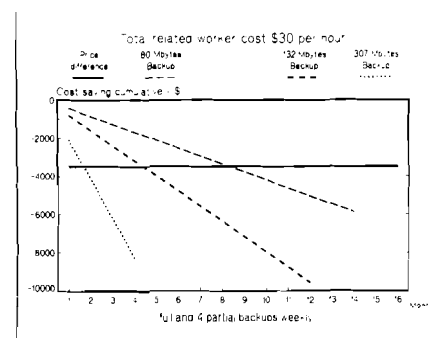

Diagram 2

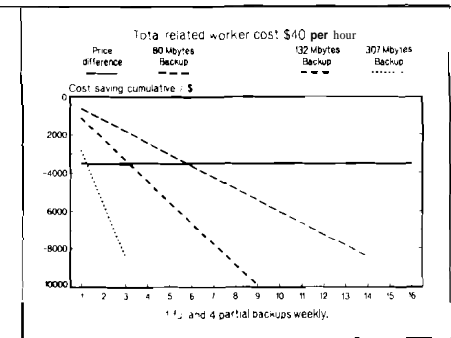

Diagram 3

The basic assumption is that a user would perform five weekly backups, of which four are partial backups and are half of a full backup in capacity. The operator cost includes overheads.

Example

The user is considering purchasing an HP MICRO 3000 full-size system with a 132-Mbyte disc drive. Either an HP 9144A or an HP 35401A could be selected as the backup device. Assuming an operator cost of \$20 per hour (Diagram 1), the justification period is seven months. This is given by the intersection of the *cumulative savings line* for 132 Mbytes with the *price difference line*.

The basis of the justification is applicable to most situations. If this is not the case, a spreadsheet that runs 1-2-3[®] from Lotus^a is available to cost justify the HP 35401A to the user's individual backup requirements.

The results indicate that the HP 35401A is an ideal match for small and midrange systems requiring backup of between 130 and 536 Mbytes. It also shows the value of presenting the argument for unattended backup in terms of a cost-justification period. Unattended backup can help you sell systems.

Successes

London Buses – Purchased 60 HP 35401As for HP MICRO 3000s.

Pepsi Cola – Purchased 15 with HP 7937H disc drives.

Dutch Government – Purchased 10 for HP 3000 Series 42s.

Sequoia Supply – Purchased 35 for HP MICRO 3000s.

Gerber – Configures the HP 35401A with technical workstations.

1-2-3® and Lotus™ are U.S. registered trademarks of Lotus Development Corporation.

Mass Storage

NEW AUTOLOADING, 1/2-INCH TAPE DRIVES: HIGH PERFORMANCE AND COMPACT DESIGN

June 1, 1987, marks the day that HP introduces a new family of high-performance, 1/2-inch tape drives leveraged to replace the current products.

The new tape family will consist of two new products. First is the HP 7980A, a 625011600 cpi, 1/2-inch magnetic tape drive designed for systems with 400 Mbytes or more of disc-backup requirements. This drive will replace the current HP 7978B tape drive. The second product, the HP 7979A, is a 1600 cpi only, 1/2-inch magnetic tape drive, providing an industry-standard solution for systems with disc-backup requirements of between 100 and 500 Mbytes. This drive will replace the HP 7974A for 1600 cpi applications, but the HP 7974A will continue to provide data interchange for systems requiring 800 cpi compatibility. Both drives are priced below their predecessors and support IBM/ANSI-compatible formats to allow software distribution and data interchange between HP and non-HP systems.

Key product features and benefits

Autoload – Both drives are standard with an autoload feature to improve

operator efficiency. Standard tape reels ranging in size from 6 to 10 1/2 inches are automatically positioned and threaded. The operator need only put the reel in the slot at the front of the drive and shut the door. The use of Easy-Load™ cartridges is not required, resulting in a more reliable autoload at a lower cost.

Compact design – The drive mechanisms in both the HP 7980A and the HP 7979A have been designed and manufactured using extensive VLSI and surface-mount technologies, yielding a small form factor. The drive is mounted horizontally in a one-meter high, standard 19-inch rack, allowing easy access for cleaning and maintenance. Enough space has been reserved in the rack for one additional mechanism, allowing maximum space utilization. Either an HP 7979A or HP 7980A tape drive can be mounted beneath the existing tape drive. Plans also include support for an HP 7936A or HP 7937A disc drive.

Reliability/maintenance – Both the HP 7979A and HP 7980A are third-generation, HP designed and manufactured tape drives. This experience in 1/2-inch tape drives has been leveraged to reduce the basic monthly maintenance cost (BMMC) by more than 50 percent: periodic maintenance is not required.

Improved performance – Both the HP 7979A and HP 7980A perform read and write operations at 125 ips. A large 512-Kbyte buffer assists the Immediate Response and Read-Ahead software features to maximize streaming performance. This greatly improves efficiency over older and slower start/stop tape drives. Available with HP 3000 systems, the new TurboSTORE backup program allows simultaneous reading or writing to multiple tape devices, dramatically improving store and restore tape operations.

Advanced front panel – Both tape drives employ a seven-character alphanumeric front display panel, showing drive status at a glance. The front panel

messages can be set by the operator from English, to French, German, or Spanish for international operation. A tape odometer is also located on the front panel, displaying the relative position of tape during drive operation.

Support on most HP 3000, 1000, and 9000 systems is planned. An OEM version of the HP 7980A (PIN 88780A) is also available, offering an SCSI or PERTEC interface for non-HP systems.

For more information, contact your HP sales rep.

Networks

HP StarLAN Now SHIPPING

HP StarLAN, Hewlett-Packard's unshielded twisted-pair wiring local area network (LAN), provides the vehicle for the industry's highest rated PC integration offering. HP StarLAN is now shipping.

The HP StarLAN products for the HP Vectra PC, IBM PC/XT/AT personal computers, MICRO 3000s, and the HP StarLAN 10 Mbps Bridge offer an ideal network for the user in an office environment requiring information exchange, file transfer to an HP 3000, database access, electronic mail, and sharing of system peripherals such as discs, printers, and, with an HP Vectra PC server, plotters.

Users can get the finest office solution, with the PC integration rated best by the leading industry consultant, and have it delivered now. For more information, refer to the HP StarLAN Data Sheet (PIN 5954-8269) or the HP Star-

LAN Cabling Specification Note (PIN 5958-9005). Contact your HP sales rep for configuration and ordering information.

¹ M. Kerstetter, "A Product Model for Departmental Computing: How Do the Major Vendors Stack Up?." *Small Computer Systems* (Gartner Group, Inc., Feb. 25, 1987), p. 34.

Networks

HP OFFICESHARE NETWORKING FAMILY FOR PCs

The HP OfficeShare Networking Family for PCs integrates personal computer users into a local area network (LAN) with PC servers and HP 3000 servers and hosts. The family includes:

- HP ThinLAN for PCs
- HP StarLAN
- HP SERIAL Network

These networking products allow PC users to share resources and access HP's distributed processing and Personal Productivity Center services to enhance communications, cut costs, and boost productivity.

HP ThinLAN for PCs provides these services to users of HP Touchscreen PC, HP Vectra PC, and IBM PC/XT/AT using RG 58 thin coaxial cable. HP StarLAN provides these services to users of HP Vectra PC and IBM PC/XT/AT using unshielded twisted-pair telephone wire meeting the IEEE 802.3 StarLAN specification. HP StarLAN has the additional benefits of lower cost and higher flexibility, often using existing telephone wiring. The HP SERIAL

Network product provides these services to a remote HP Touchscreen PC, HP Vectra PC, and IBM PC/XT/AT user over an asynchronous connection to a remote HP 3000 server or host.

All of the OfficeShare products are MS™-NET compatible, allowing applications written to the MS-NET interface to function on the network. The products also share a consistent user interface, providing easy user integration into a site-wide LAN. HP ThinLAN and HP StarLAN subnets can be connected to a baseband or broadband backbone cable running through a building to integrate the users in an entire facility. Users in a remote location can access the network services using HP SERIAL Network.

The OfficeShare networking products offer ideal networks for the user requiring information exchange, file transfer to an HP 3000, database access, electronic mail, and sharing of system peripherals such as discs, printers, and plotters. This sharing of information and peripherals provides an efficient exchange of data and use of resources for increased productivity and lower cost.

MS™-NET is a U.S. registered trademark of Microsoft Corporation.

Printers

HP LASERJET SERIES II AND LASERJET 2000 PRINTERS SUPPORTED ON HP 3000 SYSTEMS

On June 1, 1987, HP announces support of the HP LaserJet Series II and LaserJet 2000 printers on the HP MICRO 3000, 3000XE, and HP 3000 Series 39 through 70 systems. The HP LaserJet Series II printer will

be a direct replacement printer for the current HP LaserJet printer family at about a 35 percent lower price. The HP LaserJet 2000 printer offers customers a high-volume laser printer targeted for multiuser PC environments.

HP LaserJet Series II printer

Features of the new HP LaserJet Series II printer include: HP LaserJet PLUS printer compatibility, memory expansion, improved paper management (200-sheet input paper tray and 100-sheet output tray), and font flexibility.

The HP LaserJet Series II printer offers the same capabilities as the HP LaserJet PLUS printer models at more than 35 percent savings. It prints eight pages per minute and will run all of the more than 500 software programs already in use by the HP LaserJet family of printers.

HP LaserJet 2000 printer

The HP LaserJet 2000 printer is fully compatible with the HP LaserJet PLUS and LaserJet Series II printers. The HP LaserJet 2000 printer prints up to 20 pages per minute, offers full-page 300 dpi graphics on letter size paper, 34 resident fonts, and 70,000 pages maximum monthly usage – equal to six HP LaserJet printers.

The HP LaserJet 2000 printer offers a growth path for HP LaserJet printer users who need higher speed, greater paper handling, heavier usage, and lower operating costs than their current multiple HP LaserJet printer solution.

Both the HP LaserJet Series II (33440A) and the HP LaserJet 2000 (2684) printers will be supported via RS-232 connections. The HP LaserJet 2000 printer will be supported in an HP 3000 environment in a PPC pass through mode and as an HP 3000 print and space printer. Neither will be supported as a system printer. The HP LaserJet 2000 printer will **only** be supported on an ATP.

The following table lists the printer maximum that will be supported via HP 3000 systems.

HP 3000 system	Printer Maximums	
	HP LaserJet II printer (33440A)	HP LaserJet 2000 printer (2684A)
Series 37-37XE	1	0
MICRO 3000		1
MICRO 3000XE		1
Series 39-Series 58	2**	1
Series 6X, Series 70	5	2

**ATP support. Only one (1) supported via an ADCC

Inexpensive and high in performance, these new products will offer users high-quality, reliable printing solutions.

Printers

BENEFITS OF 13.3 CPI OPTION ON HP 256XB PRINTERS

All four models of the HP 256XB line impact dot matrix printer family offer an important, but often overlooked, feature – the 13.3 character per inch (cpi) compressed print option. With this feature, users can generate EDP reports on standard 8½ x 11-inch paper at 132 characters per line, landscape layout. Here's how to translate this into user benefits:

Profit improvement

- 8½ x 11-inch paper cost = \$.005 versus 11 x 14-inch (greenbar) = \$.008

This represents a 35 percent reduction in paper costs, or \$300/month for 100,000 pages.

- Eliminate photocopy reduction expense. At a print volume of 25,000 pages a month and a 5 percent volume reduction, the savings over five years would be \$6,203 (includes paper and photocopy savings.)

Productivity improvement

- 8½ x 11-inch paper is easier to handle

Space savings

- 8½ x 11-inch fits into standard notebooks and file cabinets

The 13.3 cpi options are just one more example of the flexibility found in dot matrix over band technology. Other prime advantages of the HP 256XB family include:

- Widest selection of print speeds (300, 600, 900, or 1200/1600 lpm)
- Only EDP printers that print with 'Squots' (square dots) for better readability
- Cost-effective band printer replacements
- Industry leader in reliability
- HP ranks #1 in support, per a 1986 Datapro survey.

Order Options 009 or 013 for the 13.3 cpi capabilities.* Contact your HP sales rep for more information.

* Refer to HP 256XB Family data sheet for performance considerations when using compressed character sets.

Printers

INCREASE THROUGHPUT ON HP 2567B

Although the HP 2567B was designed as a 1200 lpm line impact dot matrix printer when printing five-dot-wide and 7-dot-high characters, the throughput can be increased to 1600 lpm by installing an optional 1600 lpm draft character set in the printer (Opt. 011 and 014).

The user will trade off print quality for this gain of increased throughput. However, it is important to remember that the 1600 lpm feature is designed to provide the user with an alternative for fast, draft-quality printing for in-house reports, listings, etc.

The 1600 lpm draft character set is different from the standard character set in two ways:

- Draft characters are four-dots wide and five-dots high compared to the five-dots-wide and seven-dots-high standard character set.
- To maintain the 6 or 8 lpi line spacing, the vertical distance between dots is increased from 0.014 inches to 0.021 inches, minimizing the overlapping of dots.

Depending on paper quality, paper absorption of ink, and the age of the ribbon, dot size may vary from 0.018 to 0.22 inches. This means the dots will not always be connected vertically, and may result in microthin horizontal lines in the print.

How does this affect bar codes? The printing or readability of bar codes is not affected because the bar code character set takes the dot placement accuracy and varying dot size into account. The bar code option is designed to eliminate the spacing between dots by reducing the vertical distance from 0.014 to 0.007 inches. Also, the number of vertical dots is increased from 7 to 13 over the same distance. This high degree of overlap ensures the customer will be able to print bar codes that are solid in both vertical and horizontal directions.

To ensure satisfaction, it is recommended that the user examine a 1600 lpm draft character set print sample. Contact your HP sales rep for a print sample or help with any questions you may have.

Also in this issue

<i>HP LaserJet Printer Family Enhanced Service Training</i>	2
<i>PC/Peripherals Self-Paced Mentored Training News</i>	2
<i>Print Central and Resource Sharing Support HP LaserJet 2000 Printer</i>	6
<i>N-w Peripherals Supported on the HP 9000 Series 800</i>	17
<i>SRM I/F Card for HP Vectra PC</i>	24
<i>Prices Reduced for HP Flexible Discs</i>	31

Supplies

Supplies

FILL SUPPLY NEEDS QUICKLY WITH THE HP COMPUTER USERS CATALOG

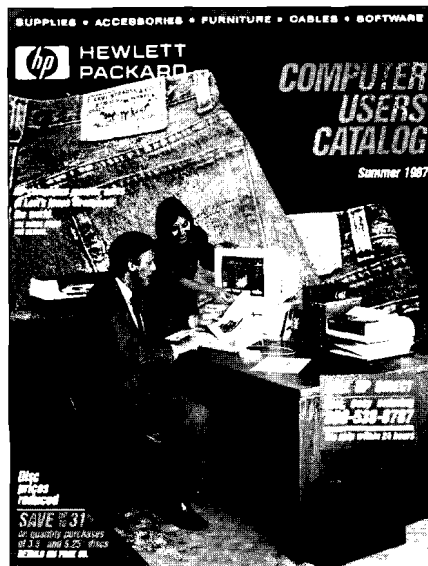

You can get the computer supplies and accessories you need – when you need them – by getting the Summer '87 *NP Computer Users Catalog*.

Distributed in early May, the *Computer Users Catalog* offers more than 1,800 products from HP DIRECT, and even helpful ideas for getting the most out of HP equipment.

Ordering is fast and easy, with tele-marketing consultants accepting orders and confirming price and product availability weekdays between 6 a.m. and 5 p.m. (Pacific Standard Time).

Phone orders are processed promptly and shipped within 24 hours of receipt. You can charge your order to HP DIRECT open accounts or VISA, MasterCard, or American Express accounts. And you'll be pleased to know that HP DIRECT provides *free* surface delivery.

What's more, the catalog has been newly designed for optimum convenience. Products are now organized into eight easy-to-use sections, headed by a simplified table of contents. There's a new how-to-order section to offer further assistance, and fresh new furniture pages to inspire purchase decisions.

The *Computer Users Catalog* also introduces new HP DIRECT products, including those listed below:

Mobile HP LaserJet printer cabinet, designed to accommodate all models of HP LaserJet printers and printer supplies.

HP LaserJet Series II printer dust cover, custom-fitted, 100 percent cotton protection against dust and spills.

HP LaserJet Series II printer supplies and accessories, includes a forward collator, paper trays, labels, overhead transparency film, font organizer, cartridge fonts, soft fonts, and tone cartridge.

HP QuietJet and HP ThinkJet printers, whisper-quiet draft printing from personal computers.

- *Surge Suppressors*, two, four, and six receptacles, to protect PCs and PC peripherals against electrical surges and transients.

- *HP StarLAN cable*, low-cost, local-area PC networking.

- *Plotstart*, high-performance, disc-based driver that works with Macintosh*) applications and HP ColorPro, HP 7475A, and HP 7550A plotters.

- *Plotter sound enclosure*, reduces the sound of HP ColorPro, HP 7470, and HP 7475 plotters by as much as 90 percent.

- *HP-28C Scientific Professional calculator*, performs symbolic math as easily as straight calculations.

- *HP Business Consultant Pocket Companion*, pocket-sized book for brushing up or quick referencing.

- *Leather infrared printer case*, protection and transportability for the Infrared

Printer available in cowhide in three attractive colors.

To order products in the *HP Computer Users Catalog* in the U.S., call HP DIRECT at toll-free 800-538-8787. Those outside the U.S. refer to the following list for U.S. and international versions of the *Computer Users Catalog*:

Product No.	Catalog
5953-2450	International edition* (English language)
5953-2450(C)	Canadian edition
5953-2450(FR)	French language edition*
5953-2450(GE)	German language edition*
5953-2450(IT)	Italian language edition*
5953-2450(UK)	U.K. edition. Order from the Literature section in the U.K. - CSC. U.K. TELNET 765-4810.
5953-2450(D)	U.S. edition. Order from the Literature Distribution Center. Palo Alto. COMSYS 0070. or send SLO

* Order by calling **HP DIRECT** at the numbers listed at the end of this section

Macintosh® is a U.S. registered trademark of Apple Computers.

Supplies

PRICES REDUCED FOR HP FLEXIBLE DISCS

Now HP's flexible discs are an even better deal. Not only are they engineered for superior, error-free performance every time, they're backed with a five-year warranty and are available at competitive prices. We've reduced our prices by as much as 26 percent. So when users buy HP discs, they're getting a top-quality product at prices that are better than ever before.

Benefits

- HP 3½-inch and 5-inch discs are rigorously tested and qualified by HP engineers to ensure 100 percent error-free performance year after year with no batch-to-batch variation.
- HP discs are precisely matched to HP disc drives for perfect compatibility and optimum performance.

- HP discs are even more economical when purchased in high volume. Quantity break discounts offer up to 31 percent off the quantity one price. Users with large usage requirements can maximize their savings by buying bulk packs of 100 discs.

For fast service, call one of the HP DIRECT telephone numbers listed at the end of this section.

Product No.	Description
92190A	5% -inch, double-sided, box of 10 discs
92190L	5% -inch, double-sided, 50 discs packaged in 5 FlexFiles
92190N	5% -inch, double-sided, box of 100 discs
92190X	5% -inch, high-capacity, double-sided, box of 10 discs
97191A	3½-inch, single-sided, box of 10 discs
92192A	3½-inch, double-sided, box of 10 discs
92192N	3½-inch, double-sided, box of 100 discs (order 92192R if disc labels required)

Supplies

HP-IL VIDEO

INTERFACE

DISCONTINUED

The HP-IL Video Interface for the HP-41, HP-71B, and HP-75C/D will be removed from the HP Price List on September 1, 1987. Last shipments will occur on August 31, 1987.

Product No.	Description
92198A	HP-IL 80-Column Video Interface (U.S. version)
92198B	HP-IL 80-Column Video Interface (European version)

For more information, contact your HP sales rep.

HP DIRECT order phone numbers

HP DIRECT Fast Phones – the easy, direct way for you to order supplies, accessories, media, furniture, and software from HP DIRECT Division.

Location	Telephone Number
Australia	(03) 895-2645 (03) 895-2615 (03) 895-2815 (03) 895-2861
Austria	(0222) 2500-615 (0222) 2500-616
Belgium/Luxembourg	(02) 762 31 11
Canada	
Toronto Local	416-671-8383
Ontario	1-800-387-3417
Quebec	1-800-387-3417
British Columbia	112-800-387-3154
Other Provinces	1-800-387-3154
Denmark	(02) 816640, ext. 258
Finland	(90) 887 2361
France	(1) 69 288 390
Greece	(01) 6726090
Italy	(02) 9236 9702
Japan	
Sagamihara	0427 59 1311
Osaka	06 304 6021
Middle East	
Athens	(01) 6828811
Norway	(02) 246090
South Africa	
Johannesburg	(011) 8025111
Cape Town	(021) 537954
Spain	(91) 6374013 (91) 6370011
Sweden	(08) 7502400
Switzerland	(057) 31 22 53 (057) 31 22 54 (057) 31 22 59
The Netherlands	(020) 547 6606
United Kingdom	(0734) 697201
United States	800-538-8787
West Germany	(0130) 3322

SOFTWARE PACKAGES

AVAILABLE AND WANTED

If you have a software package available for cross-licensing, or are looking for a package to cross-license, this section will help you. Your entry will appear for two months; the most recent additions are shaded. To list your company in the Cross-Licensing Classifieds (at no charge), see the address at the end of this section.

Software Packages Available

Industry: *Cross industry - screen management*

Abstract: SCRMS/1000 is a screen management system for HP 1000 A-Series systems using HP block-mode terminals. Since no run-time disc access is required, screens are fast, efficient, and well suited for real-time applications. Screens are defined in text files using any text editor and compiled into FORTRAN 77 or Pascal data structures with the SCRMS compiler. Run-time library procedures use the data structures to manipulate the screen. SCRMS/1000 provides such features as:

- Up to 512 unprotected and/or display-only fields
- Typed variables and arrays for field data
- Defined field types
- Full-function key support
- Display enhancement, line drawing, and escape sequence support
- EMA, CDS, and class I/O support
- IMAGE compatible
- Small size
- Extensive run-time subroutine library
- Automatic time and date fields

Company Name: Mountain States Consulting

Address: P.O. Box 151230
Salt Lake City, UT 84115
U.S.A.

Phone: 801-485-4366

Contact Person: Rick Collard

Type of Distributor Wanted: OEM/System Integrator

Geographic Coverage: Worldwide

Industry: *Manufacturing*

Abstract: The Minx Information System is a fully integrated UNIX® operating system-based financial and manufacturing application package written in "C" for the HP 9000 Series computers. The system is designed for discrete manufacturers (SIC codes 3500 to 3900) ranging in size from start up to \$250 million in revenue. Minx features include on-line help at all prompts and embedded generic search capabilities in each of the following modules:

- Order Management
- Accounts Receivable
- Accounts Payable
- General Ledger
- Report Writer
- Spread Sheet
- Cost Accounting
- Physical Inventory
- Inventory Control
- Bill of Material
- ECO Control
- Purchasing
- Shop-Hour Control
- Material Requirements Planning
- Master Production Scheduling
- Rough-cut Capacity Planning

Company Name: Minx Software Inc.

Address: 4966 El Camino Real, Suite 108
Los Altos, CA 94022
U.S.A.

Phone: 415-969-6528

Contact Person: John Meese

Type of Distributor Wanted: Dealer

Geographic Coverage: United States

Industry: *Manufacturing*

Abstract: NESTIX is an integrated NC part programming and nesting system for thermal cutting. The program includes four parts for different tasks. There is a part for transforming part geometry and manufacturing instructions into an NC part program. With the nesting part, these programmed parts are interactively nested on a raw material sheet, and with the postprocessor part, the NC cutting machine code is generated. Using the data management part, the production information (part programs, number of parts, and sheets needed, nested, cuts, etc.) is controlled.

Postprocessors are available for all major NC cutting machines and optional interfaces to different CAD and MRP systems.

Company Name: TSV-Insinöörity Oy

Address: Technology Park of Oulu
Teknologiantie 6
90570 OULU
Finland

Phone: + 358-81-500 222

Contact Person: Hannu Käkelä

Type of Distributor Wanted: Open

Geographic Coverage: Europe

Industry: Education – student loans

Abstract: On-line, fully tested student loan system composed of an integrated set of computer programs designed to assist loan personnel with the disbursement, billing, maintenance, collection, and history of student loan information. Developed and implemented at Harvard University, the loan system is capable of processing all information pertinent to a given student loan from the receipt of a loan application, until the loans are fully paid, cancelled, defaulted, or written off.

The system was written using COBOL, COGNOS (fourth-generation languages), del, View/3000, and the IMAGE database language for the HP 3000 Series 48.

Company Name: Harvard University

Address: Holyoke Center 449
1350 Massachusetts Avenue
Cambridge, MA 02138
U.S.A.

Phone: 617-495-3067

Contact Person: David Stein

Type of Distributor Wanted: Open

Geographic Coverage: Worldwide

Industry: Cross-industry, particularly land information

Abstract: ULIS is a geographical information system providing powerful mapping facilities, running on HP 9000 Series 200 and 300 (and later 800) computers with UNIX® operating system. The code is 'C.' The system includes the Starbase graphics library and integrates with HPtoday and other database software. The system permits the creation of a geographical database of vector data (point, line, circle) and non-graphical data attributes to represent any spatially distributed data by automatic map creation. The digital data can be acquired as a result of survey, digitization, or on line to numeric or graphical precision. Rasterization facilities are provided to enable fast recovery of standard map displays.

The system is most appropriate for the creation of comprehensive graphical ownership record systems (cadstral systems), public utilities systems, natural resource mapping systems, and engineering or mining information systems. Facilities to manipulate symbols and drawings enables fast creation of maps by aggregation of individual parts. The software includes a topographical mapping system extension to enable surface topology to be recorded, computed and integrated with planimetric information.

Field survey input facilities are provided as an extension and include integration with automatic data collection capabilities, running on HP-41C calculators connected to total station theodolites.

Integration with portable photogrammetric analytical stereo digitizers offers a comprehensive mapping facility.

Company Name: Kingdom Pty. Limited

Address: 5 Devlin Street
Ryde, N.S.W. 2112
Australia

Phone: +61 2 807 4822

FAX: +61 2808 1777

Contact Person: Dick Lovegrove

Type of Distributor Wanted: Open

Geographic Coverage: Worldwide

Software Packages Wanted

Type of Packages Needed: General-purpose finite element program, including preprocessor (meshgenerator) and postprocessor, or prepostprocessors alone to be attached to other company's software. Software should run under UNIX® operating system/ FORTRAN and will be ported on HP 9000 computers.

Services Provided: HP ISV with office close to downtown Munich with long-range experience in FE analysis and related fields: excellent reputation is guaranteed

Needed by: GTWD mbH Gesellschaft für Technisch-Wissenschaftliche Datenverarbeitung mbH to act as distributor or OEM.

Address: GTWDbmh
Lochhauser Str. 66
D-8039 Puchheim
West Germany

Phone: (089) 80 20 95

Fax: (089) 80 10 53

Contact Person: Dr. Willy Schweiger

Geographic Coverage: West Germany, Austria, Switzerland

You can list your company in the **Cross-Licensing Classifieds** (either Software Packages Available or Software Packages Wanted) by sending the information in the format used here to:

Hewlett-Packard Company
Value-Added Channels Development
Attn: Marilyn Rauchle
19091 Pruneridge Avenue
Building 46UV
Cupertino, CA 95014
U.S.A.

Entries will run for two months. The most recent additions are shaded. Be sure to send the information in at least one month before you wish it to appear.

How to get your name added to the distribution for *HP Channels*

If you work for a company that is a value-added business for Hewlett-Packard and want to receive your own copy of *HP Channels*, call Hewlett-Packard and have your sales rep send your name and the information requested below to Tracy Wester.

HP sales reps only: To add new U.S. or Canadian accounts to the distribution for *HP Channels*, please send Tracy Wester the following information (on HP Desk 0000/53 or to the address listed below): company name, address, phone number, OEM contract number, contacts' **name/title**, HP products used, and HP sales rep name and employee number. For accounts outside of the U.S. or Canada, contact Tracy Wester to get the name of the person who handles the distribution of *HP Channels* in your country.

Please address editorial correspondence to Tracy Wester at address listed below.

H E W L E T T · P A C K A R D

HP CHANNELS

Hewlett-Packard Company

Tracy Wester, Editor

Corporate Marketing Communications

3200 Hillview Avenue, Building 16L

Palo Alto, CA 94304-1298 USA

ADDRESS CORRECTION REQUESTED
RETURN POSTAGE GUARANTEED

 **HEWLETT
PACKARD**